

**A**

- Absorbent Socks . . . . .19
- Accel Products . . . . .34
- Adhesives . . . . .7,8,29
- Aerosol Cans . . . . .29
- Alcohol Substitute . .32,34
- Alcohol Testers . . . . .32
- Anchor Chemicals...12,29,31-33
- Anti-Static Spray . . . . .29
- Any Angle Guide . . . . .3

**B**

- Banding Press . . . . .9
- Bindery Supplies . . .1-10
- Blankets . . . . .20
- Blanket Saver . . . . .20
- Bookbinding Tape . . . . .9
- Book Clamps . . . . .3,25
- Brayers . . . . .14
- Brushes . . . . .12
- Brite Polish . . . . .29

**C**

- Chain Cleaner . . . . .20
- Channel Creasing Matrix .11
- Chemicals . . . . .29-34
- Clean-Up Sheets . . . . .22
- Corner Rounder . . . . .5
- Corner Rounding Knives .1,5
- Cotton Pads . . . . .19
- Cutter Jogging Aid . . . . .3
- Cutting Rule . . . . .12
- Cutting Sticks . . . . .2
- Cylinder Cleaner . . . . .22

**D**

- Dampening Covers . . .21
- Delivery Lamp . . . . .19
- Die Cutting Jackets . . .13
- Drill Adaptor . . . . .28
- Drill Bits . . . . .4
- Drill Blocks . . . . .5
- Drill-Ease Stick . . . . .3
- Drill Sharpeners . . . . .3

**E**

- Ear Plugs . . . . .5
- Electronic Counter . . .10
- Electrostatic Supplies .29,33
- Eyeletter, Eyelets . . . . .3

**F**

- Fast-Align Ruler . . . . .19
- Folding Bone . . . . .5
- Fountain Solution . .31-34

**G**

- Gauge Pins . . . . .13
- Glass Cleaner . . . . .29
- Gloves . . . . .12, 18
- Gum Arabic . . . . .29

**H**

- Hand Cleaner . . . . .16

**I**

- Ink Knives . . . . .14
- Ink Pads . . . . .19
- Ink Preserver . . . . .29

**K**

- Knife Guard . . . . .9

**L**

- Lead Spacing . . . . .13
- Letter Folder . . . . .8
- Letterpress
  - Numb. Mach. . . . .17
- Letterpress Rollers . . .13
- Letterpress Supplies .11-17
- Libite Typewash . . . .12,34
- Line Gauges . . . . .15,16
- Linen Tester . . . . .16
- Litho-Perf . . . . .28
- Litho-Score . . . . .28
- Litho-Slit . . . . .28
- Litho-Snap . . . . .28
- Lubricating Oil . . . . .33

**M**

- Magnetic Cutter Pads . . .3
- Magnets . . . . .14
- Magnifier . . . . .16
- Makeready Knife . . . .5,26
- Marking Tape . . . . .8
- Masking Sheets . . . . .22
- Micrometers . . . . .16
- Micro-Perf . . . . .28
- Micro-Perf Rule . . . . .12

**N**

- Numbering Machine . . .19
- Numbering Machine
  - Cleaner . . . . .12

**O**

- Offset Etch - Blue . . . .31
- Offset Press Rollers . . .30
- Oily Waste Cans . . . . .30

**P**

- Pad Counters . . . . .5
- Padding Compound . . . .7
- Padding Press . . . . .6
- Paper Drills . . . . .6

- Paper Joggers . . . . .6
- Paper Knives . . . . .2
- Paper Strapping Machine 9
- Perfect-Bind Adhesive . .7
- Perforating Rule . . . . .12
- Perforation Backing . . .13
- Perforator Blades . . . . .1
- Pile Separators . . . . .18
- Plate Punch . . . . .20
- Plunger Cans . . . . .30
- Press Supplies . . . .18-30
- Press Wash . . . . .33
- Pump Oil . . . . .20

**Q**

- Quoin Keys . . . . .14
- Quoins . . . . .14

**R**

- Razor Blades . . . . .14
- Roller Cleaner . . . . .29
- Roller Cleaning Paste .16,34
- Rudow Press
  - Parts . . . . .23-28
- Rule Cutter . . . . .12

**S**

- Safety Cans . . . . .29,30
- Scoring Blades . . . . .1,2
- Scoring Rule . . . . .12
- Sealing Wax . . . . .13
- Shim Tape . . . . .11
- Shop Apron . . . . .12
- Silicone Spray . . . . .29
- Slitting Blades . . . . .1
- Solvent Squirters . . . . .18
- Spine Taper . . . . .9
- Spray Adhesive . . . . .29
- Spray Powder . . . . .18
- Staplers . . . . .10
- Staples . . . . .10
- Static Eliminator . . . . .8
- Static Tinsel . . . . .8
- Stitching Wire . . . . .7
- Suckers . . . . .23-28

**T**

- Tablet Knife . . . . .5
- Tesaband Tape . . . . .8
- Tweezers . . . . .14
- Tympan Paper . . . . .13
- Type Wash . . . . .12,34

**W**

- Wood Furniture . . . . .14





# BINDERY

Perforator, Slitting, Scoring, Blades, Corner Cutters

### Baum & Profold Perforators - Scores - Slitters

Order #	Description	I/D	O/D	Thickness	Price
7116001	6TPerf.	.880	1.867	.062	\$6.40
7116201	12TPerf.	.880	1.867	.062	7.60
7114001	15TPerf.	.880	1.867	.035	9.40
7114201	18TPerf.	.880	1.867	.035	10.70
7116501	24TPerf.	.880	1.867	.062	7.50
7116801	31TPerf.	.880	1.867	.062	7.80
7111001	41TPerf.	.880	1.867	.032	7.10
7117501	64TPerf.	.880	1.867	.035	7.60
7276101	7TPerf	1.375	2.296	.062	17.00
7276501	15TPerf.	1.375	2.296	.062	14.40
7275301	15TSplit Perf.	1.375	2.296	.025	16.50
7276901	30TPerf.	1.375	2.296	.062	16.50
7277101	50TPerf.	1.375	2.296	.062	14.70
51941	30TSplit Perf.	1.375	2.296	.025	17.70
5132101	R.H. Slitter	.880	1.885	.09375	6.40
5132001	L.H. Slitter	.880	1.885	.09375	6.40
5131501	Slitter	.880	1.885	.062	6.20
5132501	R.H. Slitter	.880	1.885	.094	9.40
5132401	L.H. Slitter	.880	1.885	.094	9.40
5196501	Slitter	1.375	2.312	.062	11.70
5117001	Score blade (light)	.880	1.825	.059	5.03
5120001	Score blade (heavy)	.880	1.825	.125	Call
5184951	Score (full radius 3-hole)	1.375	2.296	.062	12.10
	Score (3-hole key-way)	1.375	2.306	.063	14.60

### MBO Slitters, Scores & Perforators

Order #	Description	I/D	O/D	Thickness	Price
2.0.5591.020	Score - STD	35mm	51.5	0.8mm	\$13.40
2.0.5591.080	Score - Cover Stock	35mm	50.8	0.8mm	13.40
2.0.5591.010	Slitter - STD	35mm	53.5	0.8mm	13.95
2.0.5591.090	Slitter - H/S Steel	35mm	53.5	0.8mm	13.50
2.0.5591.030	Perf. 15T	35mm	53	0.5mm	14.50
2.0.5591.040	Perf. 22T	35mm	53	0.5mm	14.60
2.0.5591.070	Perf. 12T	35mm	53	0.5mm	13.40
2.0.5591.050	Perf. 42T	35mm	52.5	0.5mm	15.80
2.0.5591.060	Perf. 70T	35mm	52.5	0.5mm	16.40
2.0.5591.X82	Perf. 82T	35mm	52.5	0.5mm	15.50
2.0.5591.100	Perf. 9T	35mm	54	1.2mm	34.20
2.0.5591.110	Perf. 16T	35mm	53	0.5mm	14.40
2.0.5591.120	Perf. 10T	35mm	53	0.5mm	14.20
50.210.020	Score - STD	40mm	59.5	0.8mm	13.40
50.210.220	Score - Heavy	40mm	60	0.8mm	13.50
50.210.550	Score - Cover Stock	40mm	58.8	1.0mm	13.40
50.210.860	Score - Wide	40mm	61.5	1.5mm	13.50
50.210.030	Slitter - STD	40mm	61.5	0.5mm	14.10
50.210.260	Slitter - for Knife	40mm	61.5	0.5mm	14.00
50.210.480	Slitter - Heavy	40mm	61.5	0.5mm	14.10
50.210.760	Slitter - H/S Steel	40mm	61.5	0.5mm	13.10
50.210.250S	Slitter - H/D for Knife	40mm	61.5	3.0mm	17.00
50.210.060	Perf. - 18T	40mm	61.5	0.5mm	14.00
50.210.050	Perf. - 12T	40mm	61.5	0.5mm	18.66
50.210.970	Perf. - 16T	40mm	61.5	0.5mm	18.66
50.210.070	Perf. - 28T	40mm	61.5	0.5mm	14.40
50.210.040	Perf. - 8T	40mm	61.5	0.5mm	14.00
50.210.450	Perf. - 10T	40mm	61.5	0.5mm	14.20
50.210.460	Perf. - 14T	40mm	61.5	0.5mm	18.66
50.210.470	Perf. - 16T	40mm	61.5	0.5mm	18.66
50.210.730	Perf. - 8T	40mm	61.5	0.5mm	14.10
50.210.630	Perf. - 6T	40mm	61.5	0.5mm	14.10
50.210.230	Perf. - 80T	40mm	60	0.5mm	16.40
50.210.240	Perf. - 48T	40mm	60	0.5mm	14.80
50.210.210	Perf. - 28T	40mm	61	0.5mm	14.40
50.210.720	Perf. - 36T	40mm	60	0.5mm	14.65
50.210.390	Perf. - 18T	40mm	60	0.5mm	14.65
50.210.400	Perf. - 8T	40mm	61.5	0.5mm	13.95
50.210.410	Perf. - 12T	40mm	61.5	0.5mm	18.66
50.210.420	Perf. - 18T	40mm	61.5	0.5mm	14.75
50.211.160	Perf. - 15T	40mm	61.5	0.5mm	14.65
60.210.260	Perf. - 10T	40mm	62	0.8mm	34.20
60.210.270	Perf. - 12T	40mm	63	0.8mm	35.00
60.210.280	Perf. - 12T	40mm	62	1.2mm	35.10
60.210.300	Perf. - 12T	40mm	64	0.8mm	35.30

### Nygren - Dahly Perforators

Order #	Description	I/D	O/D	Thickness	Price
#1	Perf. 66TPcut-out	1 1/8"	2 1/2"	1/64"	\$15.50
#3	Perf. 56TPcut-out	1 1/8"	2 1/2"	1/64"	16.50
#4	Perf. 48TPcut-out	1 1/8"	2 1/2"	1/64"	15.50
#5	Perf. 30TPcut-out	1 1/8"	2 1/2"	1/64"	15.50
#6	Perf. 22TPcut-out	1 1/8"	2 1/2"	1/64"	15.50
#7	Perf. 92TPcut-out	1 1/8"	2 1/2"	1/64"	15.50
#12	Perf. 50TP Beveled/Knife cut	1 1/8"	2 1/2"	1/64"	15.50
#29	Micro Perf. 227TP Beveled/Knife cut	1 1/8"	2 1/2"	1/64"	19.50
#30	Perf. 92TP Beveled/Knife cut	1 1/8"	2 1/2"	1/64"	16.50

### Rosback Perforators

Order #	Description	I/D	O/D	Thickness	Price
221-28-3	Slot - Perf 3TPI	1 1/4"	2 1/2"	5/32"	\$15.00
221-28-4	Slot - Perf 4TPI	1 1/4"	2 1/2"	5/32"	15.00
221-28-6	Slot - Perf 6TPI	1 1/4"	2 1/2"	5/32"	15.00
221-28-6W	Slot - Perf 6TPI	1 1/4"	2 1/2"	5/32"	15.00
221-28-9	Slot - Perf 9TPI	1 1/4"	2 1/2"	5/32"	15.00
221-28-12	Knife - Perf 12TPI	1 1/4"	2 1/2"	5/32"	15.00
221-277-3	Knife - Perf 3TPI	1 1/4"	2 1/2"	5/32"	17.00
221-277-4	Knife - Perf 4TPI	1 1/4"	2 1/2"	5/32"	17.00
221-277-6	Knife - Perf 6TPI	1 1/4"	2 1/2"	5/32"	17.00
221-277-9	Knife - Perf 9TPI	1 1/4"	2 1/2"	5/32"	17.00
221-277-12	Knife - Perf 12TPI	1 1/4"	2 1/2"	5/32"	17.00
240-297-54	Micro - Perf 54TPI	1 1/4"	2 1/2"	5/32"	65.00
240-297-72	Micro - Perf 72TPI	1 1/4"	2 1/2"	5/32"	65.00

### Stahl Slitters & Perforators

Order #	Description	I/D	O/D	Thickness	Price
5118001	Score/Cutter	30mm	46.5mm	.75mm	\$9.50
5135001	Score/Cutter	30	48	.5	7.70
5223001	Slitter	40	62.5	.75	7.70
5211001	Score/Cutter	40	61	.75	10.10
5322501	Score Blade	55	78	.5	13.20
5327501	Split Slitter	55	78.5	.5	11.40
7180501	10TPerf.	30	48	.5	11.70
7180701	15TPerf.	30	48	.5	14.10
7181301	40TPerf.	30	48	.5	14.40
7320901	12TPerf.	40	62	.5	11.70
7322101	18TPerf.	40	62	.5	12.00
7323001	28TPerf.	40	62	.5	12.80
7325001	36TPerf.	40	62	.5	13.20
7327001	60TPerf.	40	62	.5	14.60
7327601	80TPerf.	40	62	.5	14.80

### Corner Rounding Knives for Challenge Lassco & Craftsman

Size	Manufacture	Model	Knife	Die	Set	Price
1/8	Challenge	SCM	6721-2	6722-2	*	\$330.00
1/4	Challenge	SCM	6721-4	6722-4	*	330.00
3/8	Challenge	SCM	6721-6	6722-6	*	330.00
1/2	Challenge	SCM	6721-8	6722-8	*	330.00
5/8	Challenge	SCM	6721-10	6722-10	*	330.00
1/16	Lassco	20 & 50	*	*	CR-11	110.00
3/32	Lassco	20 & 50	*	*	CR-33	110.00
1/8	Lassco	20 & 50	*	*	CR-21	80.00
3/16	Lassco	20 & 50	*	*	CR-31	110.00
1/4	Lassco	20 & 50	*	*	CR-22	80.00
5/16	Lassco	20 & 50	*	*	CR-51	110.00
3/8	Lassco	20 & 50	*	*	CR-23	80.00
1/2	Lassco	20 & 50	*	*	CR-24	80.00
3/4	Lassco	50 & 60	*	*	CR-34	150.00
7/8	Lassco	50 & 60	*	*	CR-78	150.00
1	Lassco	50 & 60	*	*	CR-10	150.00
1 1/2	Lassco	50 & 60	*	*	CR-12	150.00
1/8	Craftsman	PED & BM	*	*	A100	180.00
1/4	Craftsman	PED & BM	*	*	A101	180.00
3/8	Craftsman	PED & BM	*	*	A102	180.00
1/2	Craftsman	PED & BM	*	*	A103	180.00
3/4	Craftsman	PED & BM	*	*	A104	225.00
1	Craftsman	PED & BM	*	*	A105	225.00
1 1/2	Craftsman	PED & BM	*	*	A106	225.00

\*Sold in set of Male & Female only



PERFORATION SYSTEMS INC.

1050 33rd Ave. SE Ste. 1000

1-651-917-8444 1-800-829-4815

## Dyna-Score

### Letterpress Quality Scores

for Stahl & MBO Folders

**Wide Score**  
Available in 30mm and 35mm sets  
Note: Narrow score for thin cover and 100 lb offset stock.

Cat. #	Shaft Size	Price
DS/2230mm	30mm	\$265.00
DS/2235mm	35mm	265.00

**Narrow Score**  
Available in 30mm and 35mm sets  
Note: Narrow score for thin cover and 100 lb offset stock.

Cat. #	Shaft Size	Price
DS/2930mm	30mm	\$265.00
DS/2935mm	35mm	265.00

Correct Cover & 100 lb. offset

Note: W on side indicates wide track

### CUTTING STICKS

- "BLADE-SAVER"<sup>TM</sup> cutting sticks will out-perform any other plastic stick at any price.
- Super tough "BLADE-SAVER"<sup>TM</sup> cutting sticks will outwear wood sticks by at least four times.
- Compare "BLADE-SAVER"<sup>TM</sup> cutting sticks with any other stick, you will agree that ours is the most economical stick you can use.

All sticks are available in white plastic unless otherwise specified.

- \* DESIGNATES RED PLASTIC
- \*\* DESIGNATES DURAFLEX FIBRE

#### CHALLENGE - CHANDLER & PRICE - MARTIN YALE $\frac{1}{2}'' \times \frac{1}{2}''$

Cat. #	Length	Price	Cat. #	Length	Price
CUP-195	19 $\frac{1}{8}''$	\$1.35 ea.	CUP-320	32"	\$2.16
CUP-20	20"	1.40 ea.	CUP-345	34 $\frac{1}{2}''$	2.40
CUP-23	23"	1.56 ea.	CUP-365	36 $\frac{1}{2}''$	2.50
CUP-265	26 $\frac{1}{2}''$	1.85 ea.	CUP-37	37"	2.50
CUP-27	27"	1.85 ea.	CUP-374	42"	2.85
CUP-305	30 $\frac{1}{2}''$	2.10 ea.			

#### LAWSON PACEMAKER - SEYBOLD $\frac{3}{4}'' \times \frac{3}{4}''$

Cat. #	Length	Price	Cat. #	Length	Price
CUP-393	33"	\$3.40 ea.	CUP-42	42"	\$4.30 ea.
CUP-39	39"	4.00 ea.	CUP-45	45"	4.65 ea.
CUP-40	40"	4.10 ea.	CUP-47	47"	4.85 ea.
CUP-41	41"	4.20 ea.	CUP-51	51"	5.25 ea.

### PAPER KNIVES

**SUREKUT**<sup>®</sup> More Surekut Family Knives are sold in the United States than all other standard quantities combined.

#### Durakut<sup>†</sup> Paper Knives

Advanced steel blade tungsten performance production output up to five times more cuts per grind compared with standard grade knives.

#### Ultrakut<sup>™</sup> - Paper Knives

Tungsten carbide inlay cutting edge precision ground & polished to a razor sharp, mirror finish cutting edge. Fewer knife changes increase productivity up to 25 times more than standard grade knives.

For assistance in selecting the proper grade for a specific application, call PERFECTION toll free. 1-800-829-4815

**TO ORDER PLEASE HAVE MAKE (MFG.) MODEL, SERIALNO. OF YOUR CUTTER.**

### CUTTING STICKS - continued

#### POLAR- SWANECK PRO-CUT $\frac{3}{16}'' \times \frac{3}{8}''$

Cat. #	Length	Price	Cat. #	Length	Price
*CUP-55	22"	\$16.20/doz	*CUP-90	35 $\frac{1}{8}''$	\$27.36/doz.
*CUP-72	28 $\frac{3}{4}''$	21.65/doz	*CUP-92	36 $\frac{1}{2}''$	27.36/doz.
*CUP-76	30 $\frac{1}{4}''$	22.95/doz	*CUP-P105	42 $\frac{3}{8}''$	31.67/doz.
*CUP-P80	31 $\frac{1}{8}''$	26.88/doz.	*CUP-P112	44 $\frac{3}{8}''$	33.40/doz.
*CUP-SW	32"	27.00/doz.	*CUP-P115	45 $\frac{3}{8}''$	33.91/doz.
*CUP-82	32 $\frac{1}{2}''$	27.00/doz.			

#### LAWSON REGENT- WOHLBERG $.585 \times .585$

Cat. #	Length	Price	Cat. #	Length	Price
CUT-90P	35 $\frac{3}{8}''$	\$ 4.00 ea.	CUT-115P	45 $\frac{3}{8}''$	\$ 5.25 ea.
CUT-92P	36 $\frac{3}{8}''$	4.10 ea.			

#### WOHLBERG $.511 \times .511$

Cat. #	Length	Price	Cat. #	Length	Price
**CUT-90D	35 $\frac{3}{8}''$	\$ 12.85 ea.	**CUT-115D	45 $\frac{3}{8}''$	\$ 18.50 ea.
**CUT-92D	36 $\frac{3}{8}''$	15.15 ea.			

#### WOHLBERG $.155 \times .394$

Cat. #	Length	Price	Cat. #	Length	Price
* CUT-SPM	30 $\frac{3}{32}''$	\$ 4.95 ea.	*CUT-MCS	36 $\frac{3}{8}''$	\$ 8.20 ea.

#### MICHAEL- MAXIMA- MARTIN YALE - EBA $\frac{9}{16}'' \times \frac{9}{16}''$

Cat. #	Length	Price	Cat. #	Length	Price
CUP-T14	14 $\frac{1}{8}''$	\$1.57 ea.	CUP-T22	22 $\frac{3}{8}''$	\$ 3.40 ea.
CUP-T18	18 $\frac{1}{16}''$	2.15 ea.	CUP-T25	25 $\frac{3}{8}''$	3.80
CUP-E22	22"	2.25 ea.	CUP-MAX	31 $\frac{1}{16}''$	3.90
CUP-T22NS	22 $\frac{1}{16}''$	3.25 ea.			

#### MICHAEL- ROYALZENITH $\frac{5}{8}'' \times \frac{5}{8}''$

Cat. #	Length	Price	Cat. #	Length	Price
CUP-T23	22 $\frac{3}{8}''$	\$ 2.36 ea.	CUP-T3018	30 $\frac{3}{8}''$	\$3.20 ea.
CUP-T24	24 $\frac{3}{8}''$	2.60 ea.	CUP-RZ	45 $\frac{3}{8}''$	4.78 ea.
CUP-T30	30"	3.10 ea.			

MANY OTHER SIZES NOT LISTED ARE AVAILABLE, JUST CALL PERFECTION FOR PRICE AND AVAILABILITY.



**CUTTER JOGGING AID BLOCKS**

- Heavy duty solid Kimo-Plastic
- Magnetic base helps jog bottom sheets perfectly
- Keeps hands from blade



Cat. #	Size	Price
JA-308	3" High x 8" Long	\$35.00
JA-310	3" High x 10" Long	45.00
JA-408	4" High x 8" Long	36.00
JA-410	4" High x 10" Long	45.00
JA-510	5" High x 10" Long	50.00
JA-518	5" High x 18" Long	90.00

Other sizes available

**PAPER STOCK ANGLE GUIDE**

Cut corners off statements, tags, etc. at 45° angle. Use attachment (furnished) to cut diamond-shaped angles, triangles or any other angle. INSTANTSETTING - Place angle guide against stock cutter gauge and set cutter to necessary measure.

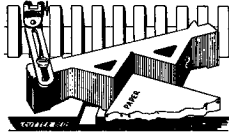

**Cat. # A-WG** Any Angle Guide.....\$84.60

**BOOK CLAMPS GARDNER**

Attach to back gauge of cutter to hold down folded or stitched edge of booklets, catalogs, pamphlets, pair.

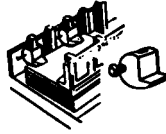

**Cat. # BN-22**.....\$24.00

Book Trimming Guides. Economy style. Fits on back gauge of cutter.

**3M MAGNETIC PADS**

**DURABLE CONSTRUCTION – SAVES TIME** – Just position the Mag Pad and start cutting. No tools needed. Stays put magnetically but removes easily. **SAVES MONEY** – The 3M Mag Pad leaves no clamp marks on carbonless papers or damage to top sheets of other pressure responsive stocks. **USE ANYWHERE** – It can be cut for exact fit for any cutter without any loss of magnetism. Comes in package of two 3" x 15" strips.

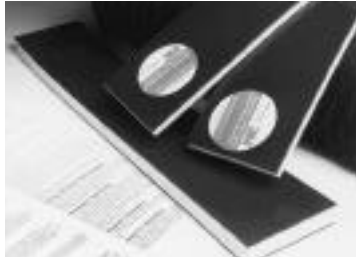

**Cat. # M-3M**.....\$32.80/pkg.

**BATES AUTOMATIC EYELETTER**

- Adjustable
- Loads 150 Eyelets
- Throat depth 2 1/2"
- Thousands in use

(Prices of eyelets shown below)

Where speed is desired and there is quality eyeletting to be done, this automatic eyeletter is absolutely in a class by itself. It feeds the eyelets, punches the hole, and crimps the eyelet in one automatic operation.



**Cat. # EY-B40** Model 40 eyeletter..... \$340.00

**STANDARD EYELETS**



**Cat.# EY-B1** . . . . Short Eyelets .....per box of 1000 \$13.65

**Cat.# EY-B2** . . . . Medium Eyelets .....per box of 1000 14.00

**Cat.# EY-B3** . . . . Long Eyelets .....per box of 1000 14.10

**SPINNET® DRILL SHARPENER**

*With Solid Carbide Cutting Head*



This precision sharpener has self-seating, lathe-type construction on heavy duty base and sharpens most brands of drills from 1/8" to 1/2"

**Cat. # DZ-R68M** DrillSharpener \$140.00

**Cat. # MSI-06** Replacement Cutting Unit 39.00

**UNIVERSAL DRILL SHARPENER**

Just tell us what type of paper drilling machine you have and we can supply our sharpener with the correct drill holder.

**Cat. # DZ-R68H** Universal Sharpener \$169.50

For a small additional charge we can supply a separate holder, or holders for Nygren-Dahly, Challenge, Lawson and many other drill cutters.

• Each additional head \$49.50 each

**POWER DRILL SHARPENER**

For use with Challenge drilling machines. We recommend the purchase of this sharpener for multiple spindle drills. You can sharpen several hollow drill bits to the same length for easier adjusting of the heads.

115 Volt, 60 Hz Motor.

**Cat. # DZ-R68P** Power Sharpener \$650.00

**Cat. # DZ-R68** ReplacementCutting Bit 96.00

**SHARPENING SERVICE**

We sharpen your dull hollow paper drill bits  
 LIKE NEW .....\$4.25 ea.  
 We also sell **used bits** for 1/2 the price of what new ones cost, call Perfection for availability.

**DRILL EASE LUBE STIK**



Reduces Friction • Prevents Burning

• Easy to apply like a crayon

**Cat. # DZ-R60**

\$2.25 ea.

12+ \$1.60 ea.

24+ \$1.45 ea.

**CHALLENGE HOLLOW DRILL SHARPENER**

A sharp paper drill is important to the best performance of your paper drilling machine. Keeping a drill sharp increases production – cuts down drilling time and drill breakage. **For clean, fast drilling and longer drill life.**



**Cat. # DZ-R64**

Sharpener \$75.00

**Cat. # DZ-R66**

Replacement Bit \$37.00



# BINDERY

Drill Bits – Challenge, Nygren Dahly, C & P, Lassco, Martin Yale, IRAM

SPECIALLY MADE FROM  
HIGH CHROME TOOLSTEEL

MICRO SMOOTH MIRROR FINISH  
FOR EASYCHIP PASSAGE

HARDENED SHAFT ADDS TO  
LONGER DRILLUSAGE

## CHALLENGE (2" Capacity)

### LASSCO, OTTAWA

Cat #	Size
DZ-C10	1/8"
DZ-C14	5/32"
DZ-C18	3/16"
DZ-C22	7/32"
DZ-C26	1/4"
DZ-C34	17/64"
DZ-C38	9/32"
DZ-C42	5/16"
DZ-C50	11/32"
DZ-C54	3/8"
DZ-C62	13/32"
DZ-C64	7/16"
DZ-C66	1/2"



\$18.90/ea.

\$17.96/ea. 3 or more

#### Special large hole bit

DZ-C80 9/16"

\$110.00/ea.

## CHALLENGE (2 1/2" Capacity)

Cat #	Size
DZ-C30	1/4"
DZ-C46	5/16"
DZ-C58	3/8"
DZ-C70	1/2"

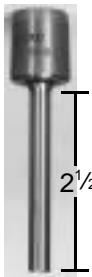

\$21.25/ea.

\$20.19/ea. 3 or more

## IRAM (3" Capacity)

Cat #	Size
DZ-M10	1/8"
DZ-M13	3/16"
DZ-M18	1/4"
DZ-M20	9/32"
DZ-M22	5/16"
DZ-M26	3/8"
DZ-M50	1/2"

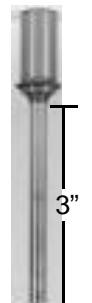

\$46.00/ea.

## NYGREN DAHLY (2" Capacity)

Cat #	Size
DZ-N10	1/8"
DZ-N14	5/32"
DZ-N18	3/16"
DZ-N22	7/32"
DZ-N26	1/4"
DZ-N30	9/32"
DZ-N34	5/16"
DZ-N38	3/8"
DZ-N42	13/32"
DZ-N50	1/2"



\$18.90/ea.

\$17.96/ea. 3 or more

## LASSCO (1" Capacity)

Cat #	Size
DZ-L10	1/8"
DZ-L12	5/32"
DZ-L14	3/16"
DZ-L16	7/32"
DZ-L18	1/4"
DZ-L20	9/32"
DZ-L22	5/16"
DZ-L24	11/32"
DZ-L26	3/8"
DZ-L28	7/16"



\$23.00/ea.

\$21.85/ea. 3 or more

## CHANDLER AND PRICE PIONEER (1 1/2" Capacity)

Cat #	Size
DZ-D08	1/8"
DZ-D09	3/16"
DZ-D10	1/4"
DZ-D14	3/8"
DZ-D18	5/16"



\$18.90/ea.

\$17.96/ea. 3 or more

## LAWSON (2 1/4" Capacity)

Cat #	Size
DZ-A10	1/8"
DZ-A12	3/16"
DZ-A14	1/4"
DZ-A18	5/16"
DZ-A22	3/8"
DZ-A26	1/2"

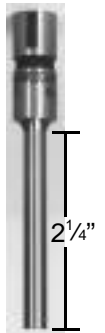

\$18.90/ea.

\$17.96/ea. 3 or more

## MARTIN YALE 202(K) LIHIT (2" Capacity)

Cat #	Size
DZ-K05	1/8"
DZ-K10	3/16"
DZ-K12	1/4"
DZ-K14	5/16"
DZ-K38	3/8"
DZ-K50	1/2"

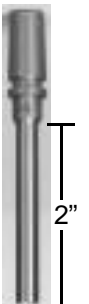

\$49.00/ea.

\$80.00/ea

## MARTIN YALE 101 (J) LIHIT (1" Capacity)

Cat #	Size
DZ-J10	1/8"
DZ-J18	1/4"
DZ-J20	9/32"

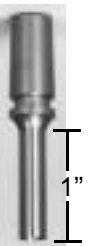

\$49.00/ea.

## TEFLON COATED DRILLS

Perfection can supply these special coated bits that greatly reduce heat build-up and friction for Nygren-Dahly, Lassco, Challenge, Lawson and IRAM.

\$26.45 for 2" Capacity Drilling

\$28.75 for 2 1/2" Capacity Drilling

\$32.20 for 3/2" or Longer (Except IRAM)

- Note 5% DISCon 3 or more -

\*\*This range of standard drill sizes are carried in stock to meet your every ordinary drilling need. Order by number and size.\*\*

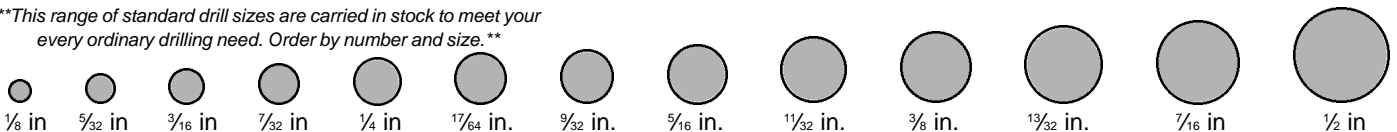

1/8 in. 5/32 in. 3/16 in. 7/32 in. 1/4 in. 17/64 in. 9/32 in. 5/16 in. 11/32 in. 3/8 in. 13/32 in. 7/16 in. 1/2 in.



PERFECTION TOOL CO. INC.

1050 33rd Ave. SE Ste. 1000

1-651-917-8444 1-800-829-4815

# BINDERY Drill Blocks, Pad Counter, Tablet Knife, Folding Bone, Cornerounder, Ear plugs

## DRILL BLOCKS

- Made from Endgrain Rock Maple
- Sizes available for almost any make of drill



## CHALLENGE

Cat. #	Size	Price
DZ-R25	1½" dia. x ¾"	\$ 5.25/doz.
DZ-R30	2½" dia. x ¾"	9.55/doz.
DZ-R35	3" dia. x ¾"	13.30/doz.
DZ-R15C	1¼" x 6" x ⅜"	5.25/doz.
DZ-R15	1¼" x 6½" x ⅜"	5.25/doz.

## LAWSON

Cat. #	Size	Price
DZ-R20	1⅞" x 8½" x ⅜"	\$ 5.90/doz.

## NYGREN-DAHLY

Cat. #	Size	Price
DZ-R15	1¼" x 6½" x ⅜" (std.)	\$ 5.25/doz.
DZ-R10	1¼" x 6½" x ⅜" (N/S)	6.00/doz.

## PIONEER

Cat. #	Size	Price
DZ-R40	2¼" dia. x ¾"	\$ 9.50/doz.

## SPINNIT

Cat. #	Size	Price
DZ-R45	2⅜" dia. x ⅝"	\$ 1.10/ea.
DZ-R50	2" x 16" x ½"	9.00/ea.
DZ-R52	2" x 25" x ½"	8.50/ea.

## IRAM (plastic)

Cat. #	Size	Price
DZ-R41	10" x 1" x ⅜"	\$ 15.00/doz.

## MARTIN YALE

Cat. #	Size	Price
MRS101A00	1" x 11¼"	\$ 21.00 Pkg/6
MRS202B00	2⅜" x 11¼"	23.00 Pkg/5

## PERFECTION

### PAD COUNTER

Adjustable for dividing into equal parts for padding. Nickel plated.

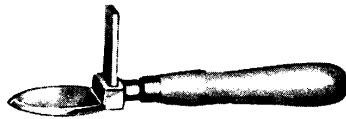

Cat. #	Description	Price
P-C2	2" Capacity	\$8.95
P-C5	5" Capacity	11.00

## QUICK AS A WINK

### PAD COUNTER

A pad counter that divides paper as quick as the wink of an eye.



To instantly divide into 5 equal parts any pile up to a maximum thickness of 2 ½ in. This simple device makes the rapid and accurate division of a pile of sheets into 5 equal parts an easy job.

Cat# P-CW \$3.75 ea.

## TABLET KNIFE

Cat. #TA-101  
\$8.40

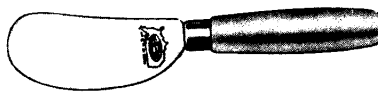

## FOLDING BONE, 7-inch

Polished and rounded flat bone for hand folding.



Cat. # F7.....\$3.50

## OLFA A STANDARD CUTTER



Cat. # MK-300 Cutter with 2 Extra Blades \$ 5.50  
Cat. # MK-10 Cartridge of 10 Extra Blades 6.50

## LASSCO DESK TOP CORNEROUNDER®



### MODEL(CR-20)

The model 20 desktop Cornerounder® handles up to ½" of stock per cut. Equipped with your choice of one cutting unit: ⅛", ¼", ⅜", or ½". The table leaf extends to accommodate 8 ½" x 11" or larger sheets.

\* Capacity of cutting unit is dependent on

material being cut and radius of unit being used.

### Standard Cutting Unit Diagram

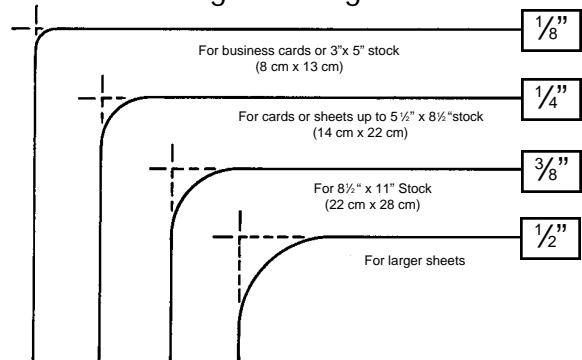

Cat#	Description	Price
CR-20	Cornerounder® w/cutting unit	\$149.00
CR-21	1/8" cutting unit	80.00
CR-22	1/4" cutting unit	80.00
CR-23	3/8" cutting unit	80.00
CR-24	1/2" cutting unit	80.00

## ULTRA SOFT EAR PLUGS deaden noise fast!

These ear plugs filter a (22dB noise reduction rating.) while allowing normal communication frequencies to pass. The pre-shaped core eliminates the need for forming for comfortable insertion and removal, with a natural air flow to relieve that "plugged-up" feeling. Individual pair packaging provides optimum hygiene.



Cat#	Description	Price
EP-5121	Wall Dispenser w/400 pr. plugs	\$126.95
EP-5120	400 pair of Ultra Soft Refills	.22/pr.



## SPINNIT® PAPER DRILLS BY LASSCO

**Bench Model  
(EBM-2)**

A rugged compact drill that provides high production at low cost. Equipped with 2" drilling capacity and transversing table for easy multi-hole drilling.

**Cat#** Price  
EBM-2 \$850.00



**Spinnit®  
3 Spindle Floor Model  
(FMM-3)**

This new Lassco 3 spindle drill offers a 2" drilling capacity, easy movable head design, rugged mechanical lift table which smoothly transverses in either direction. Built for ease in operation and maximum production performance, includes MS-1 Drill Sharpener.

**(FMMS-3)**  
Identical to FMM-3 except with stationary heads for drilling 3 holes, 4 1/4" on center.

**Cat#** Price  
FMM-3 \$3650.00  
FMMS-3 \$2850.00



## SYNTRON® VIBRATING JOGGERS

**Bin Type Jogger  
Model J-1**

The Model J-1 with single bin is perfect for use with small offset presses or duplication machines. The easy access single bin rack enables it to deaerate and align up to 1 1/2 reams of tightly packed copier paper, assuring automatic one-at-a-time feeding. The J-1 can handle paper forms ranging from the smallest cards to 8 1/2" by 14" legal size sheets. Weighing only 25 pounds, it can be easily moved wherever its jogging action is needed.

**Cat#** .....J1ST Price .....\$551.00



**Flat Deck Jogger  
Model J-50**

The Model J-50 a popular and versatile jogger, is equipped with a 14" x 20" or 17" x 22" flat hardwood maple deck. The unit's single-action vertical vibration will jog lifts of paper stock in sizes up to 17" x 22" and loads weighing as much as 50 lbs. Designed for bench or table work, this compact, space-saving jogger can be supplied with a portable stand if desired.

**Cat#** .....J50B-14 x 20 Price .....\$930.00  
**Cat#** .....J50F-17 x 22 Price .....\$930.00  
**Cat#** .....J50 STAND Price .....\$242.00



## CHALLENGE® PADDY WAGON® PADDING PRESS

- Easy Operation
- Large Capacity
- Self-aligning Gravity Load
- Fast Lock & Release Clamping
- High Production Padding
- Superior Quality
- Affordably Priced
- Portable



### Paddy Wagon Specifications

#### Physical Dimensions

Overall Dimensions .....30 x 30" (76 x76 cm)  
Height.....66 1/2" (170 cm)  
Net Weight.....100 lbs (45 kg)  
Shipping Weight .....120 lbs (55 kg)

#### Padding Capacity

Maximum Pile Width.....23 1/2" (60 cm)  
Maximum Pile Height.....31" (80 cm)  
Pile Depth .....3" to 17+" (8 to 43+ cm)  
Fits easily through any standard 32" (80 cm) doorway

**Cat#** ..... PADWAG **Price** .....\$695.00

## PADDING PRESS

### The New Jiffy Giant

Now you can own the best padding press available for your shop, and spend far less than you'd expect! The Jiffy Giant provides sturdy, all metal construction. Handy for padding carbonless forms, scratch pads and note pads.

**Cat. # P-P18** .....\$160.00



- Simple sturdy metal construction.
- Wing screws tighten – by hand – no tools necessary.
- Tip back to assure that stock is always square.
- Measures just 19" W x 24" H x 13" D – takes up minimal amount of space.
- Holds paper firmly in place while you apply glue.
- Makes up to 30" pads.
- For ease of movement optional casters are available.
- For production efficiency buy several.

# BINDERY Stitching Wire, Adhesives, Pastes, Tacky Finger

## STITCHING WIRE 5 LB. SPOOLPRICING/10 SPOOLS PER CASE

### Pre-Lubricated

Lightly lubricated wire provides you with smoother running wire and less wear on your stitcher head.

### Low Tension Spooling

Our exclusive low tension spooling process provides you with smoother take off and reduces tangles.

Cat. #	Size	0-9	10-49	50-99	100+
SWA-1	18	8.90	6.85	5.95	5.55
SWB-1	20	10.10	7.75	6.75	6.30
SWC-1	23	10.00	7.70	6.65	6.25
SWD-1	24	10.40	8.00	6.95	6.50
SWE-1	25	10.20	7.85	6.80	6.40
SWF-1	27	12.10	9.30	8.10	7.55
SWG-1	28	12.50	9.60	8.35	7.80
SWH-1	18 x 20	9.20	7.10	6.15	5.75
SWI-1	19 x 21½	10.10	7.75	6.75	6.30
SWJ-1	20 x 24	10.40	8.00	6.95	6.50
SWK-1	20 x 25	10.20	7.85	6.80	6.40
SWL-1	21 x 25	10.30	7.90	6.90	6.45

**NOTE:** 10, 20, & 70 lb spools are available upon request, contact Perfection for price and availability.

All wire is available in three hardness levels. All pricing above is for standard hardness. Also available for a few pennies more per pound are:

"X" for a slightly stronger stitch and

"XXX" for the toughest stitching jobs – it's tough as nails!

*Note: Copper, brass, stainless steel, and colored wire are also available, contact Perfection for price and availability.*

## ROUND BOOKBINDERS WIRE

Gauge	Size	Inches Per Lb.	Feet Per Lb.	Recommended Inch Thickness of Work
18	047	1992	166	5/8-2
19	041	2676	223	
20	035	3708	309	1/2-1
21	032	4476	373	5/16-5/8
22	028	5496	458	
23	025	6756	563	1/8-3/8
24	023	8496	708	1/16-1/4
25	021	10800	900	1/16-7/32
26	018	13728	1144	Up to 3/16
27	017	15036	1253	Up to 1/16
28	016	17148	1429	2-16 Sheets
30	014	22956	1913	2-10 Sheets

## FLAT BOOKBINDERS WIRE

Gauge	Size	Inches Per Lb.	Feet Per Lb.	Recommended Inch Thickness of Work
18 x 20	047 x 035	2544	212	5/8-2
19 x 21½	041 x 030	3396	283	1/2-1
20 x 23	035 x 025	4071	339	Up to 7/8
20 x 24	035 x 023	4896	408	Up to 13/16
20 x 25	035 x 021	5448	454	1/8-5/8
21 x 25	032 x 021	6708	559	1/16-1/2
22 x 26	028 x 018	7800	650	

## ADHESIVES PADDING COMPOUND



■ Excellent adhesive for all general book binding work, non-flammable, will not crack, chip or flake even when bent double. Dries in 15-minutes.

Cat. #	Color	Unit	Price
A-DR-5	Red	Quart	\$ 8.06
A-DR-51	Red	Gallon	18.87
A-DR-55	Red	5-Gal. Pail	88.23
A-DW-5	White	Quart	8.06
A-DW-51	White	Gallon	18.87
A-DW-55	White	5-Gal. Pail	88.23

## CARBONLESS PADDING COMPOUND

■ This product provides excellent adhesion on all NCR, 3M and NASHUA-type papers. Never a problem fanning apart and rapid drying distinguishes this from the rest water soluble for easy clean-up.

Cat. #	Unit	Price
A-1085	Quart	\$ 14.60

## BAUM FOLDER PASTE

Smooth paste that is suitable for use in Baum Folder, Cleveland Folder and other folding machines.

Cat. #	Unit	Price
A-219	Gallon	\$ 23.85
	4+	22.15

## NON-WARP PASTE

Paste is used for most any materials. Thin the paste by stirring well. If desired thinner, or if paste has hardened from evaporation, stir well and add a small amount of water.

Cat. #	Unit	Price
A-249	Gallon	\$ 23.85
	4+	22.15

## COLLATING ADHESIVE

White adhesive that sticks quickly, but dries slowly. Designed for use in mendes machine and other collating equipment. Shows little tendency to skin-over in glue pan.

Cat. #	Unit	Price
A-3792	Gallon	\$ 23.40
	4+	21.75
A-37925	5-gal. pail	109.50

## BOOK BINDING ADHESIVE

White in color hot-melt glue, supplied in pellet form for use in all binding machines listed below under manufacturer.

Cat. #	Model	Unit	Price
A-61-1100	Bindfast -5	21.6/lb. ctn.	\$162.80
A-61-1025	Bindfast -5	50.0/lb. ctn.	290.00
A-61-200	Rosback 200 (Bind-0-Mat)	8/qts. ctn. 5+ ctns	80.00 70.00

**PERFECT BINDER GLUE**, White in color, that can be used in single clamp rosback 880 & Sulby Mini Binder machines.

Cat. #	Model	Unit	Price
A-880-400	Rosback/Sulby	48.0/lb. ctn.	\$170.00
A-880-500	Rosback/Sulby	48.0/lb. ctn.	180.00

## TACKY FINGER

A finger tip moistener for handling paper with greater speed and accuracy. Tacky Finger is stainless, greaseless and odorless.

Cat. #	Unit	Price
TA-600	2.5/oz. box	\$ 2.25





# BINDERY Glues, Tesa Tape, Marking Tape, Static Eliminator, Static Tinsel

## HI-SPEED GLUE FOR ALLGLUING SYSTEMS

### PERMANENT ADHESIVE

This glue can be used in most all glue systems. It is most commonly used for the spine gluing of signatures.

Cat. #	Description	Unit	Price
33-9170	Permanent Adhesive	Gal.	\$30.35

### FUGITIVE CRODAAPEX ADHESIVE

This synthetic adhesive is ideal for use on coated stock and can be used in all types of gluing systems.

Cat. #	Description	Unit	Price
57-484	Fugitive Synthetic	Gal.	\$41.55

### FUGITIVE LATEX ADHESIVE

This glue is strictly used in only HHS pressurized glue systems or all other contact type systems such as Moll, Pafra, etc., it basically is used on hi-bulk uncoated stock & fibrous paper.

Cat. #	Description	Unit	Price
27LA.9006	Fugitive Latex Adhesive	Gal.	\$48.60

*Note: Fugitive means product can be opened with minimal tear damage to fiber of paper.*

### PRE-EXTRUDED HOT MELT DOTS ON A ROLL

Dots of removable adhesive with thousands of uses, packaged in a handy dispenser box for easy application.

**NO MORE STRINGYMESS!**

A clean, safe way to apply adhesive.

#### ATTACH ITEMS TO BROCHURES

- Free Samples
- Packets
- Coupons
- Membership Cards

#### SIMPLE & FAST TO USE

- No LIner to Peel Off
- No messy Liquids
- No Equipment to Buy
- Easy to Use Dispenser Box

\*\*4000 Actual dot samples glued to paper on each roll\*\*

Low Tack	High Tack	Super High Tack
Cat.# LT-GD	Cat.# HT-GD	Cat.# SHT-GD
	All rolls priced \$ 51.40 ea	
	12+ rolls \$45.70 ea	

Now available: Super High Tack for permanent glue applications.

### TESABAND TAPE

When your rollers lose their grip, gray fold roller tape gives new life to grippless rollers. It is ultra thin and doesn't drastically increase surface diameter of rollers.



Cat. # TA-R34 Tesaband Tape  
3/4" x 27.5 yd. ....\$79.20 ea.

### MARKING TAPE for TAB Setting counters.

Cat. # TA-G1 Badger Marking Tape.....\$4.50 ea  
1" wide x 7" dia. Case of 30 rolls .....108.45 case

Call toll free **1-800-829-4815** and let us help you place your order, check the status of an existing order or help you solve a problem in purchasing your next pre-press or bindery related supply needs.

## IONIX STATIC ELIMINATOR

### Now Carbonless Stock Runs Like Bond & Coated Stock Runs like Offset!

A revolutionary patented in-line paper static eliminator that uses the air from your feeder's blower pump to eliminate static in your paper BEFORE it enters your press! No Jams!

Faster press speeds! Also works on folders, collators, sheeters, mailing machines and web sheeters!



**Easy to Install!**

Simply cut the blower line from your compressor which goes to your feeder and insert Ionix™ Static Eliminator. Now the air from your compressor will have a positive charge – eliminating static! Plus it's Environmentally Safe & **Guaranteed**

(Ask for details when ordering)

#### For Sheet Fed Presses & Folders:

- For sheet size up to 14"x19" AND
  - Model 100-1 for hose with 1/2" inside diameter.....\$89.00
  - Model 100-2 for hose with 3/8" inside diameter.....\$89.00
  - Model 100-3 for hose with 3/4" inside diameter.....\$89.00
  - Model 100-4 for hose with 1" inside diameter .....\$89.00
  - Model 100-5 for hose with 1 1/4" inside diameter .....\$89.00
- For sheet size over 14"x19" and up to 22"x 34" AND
  - Model 200-1 for hose with 1/2" inside diameter.....\$119.00
  - Model 200-2 for hose with 3/8" inside diameter.....\$119.00
  - Model 200-3 for hose with 3/4" inside diameter.....\$119.00
  - Model 200-4 for hose with 1" inside diameter .....\$119.00
  - Model 200-5 for hose with 1 1/4" inside diameter .....\$119.00
- For sheet size over 22"x34" and up to 26"x 40" AND
  - Model 300-1 for hose with 1/2" inside diameter.....\$155.00
  - Model 300-2 for hose with 3/8" inside diameter.....\$155.00
  - Model 300-3 for hose with 3/4" inside diameter.....\$155.00
  - Model 300-4 for hose with 1" inside diameter .....\$155.00
  - Model 300-5 for hose with 1 1/4" inside diameter .....\$155.00

### STATIC TINSEL

Tinsel wrapped cord with copper core. Conducts static charges away from paper when grounded. For use on all industrial machines, printing presses, folding machines, etc.  
24 yd. Boxes



Cat. # STS-42 – box \$12.85, Case (12 boxes)..... \$135.00



### INSTANT LETTER FOLDER

Just drop one to three sheets of standard 8 1/2" x 11" paper (from 16-24# bond, even in stapled sets) into the "in" slot and a precisely folded letter emerges automatically! No set-up required, just plug it in and insert the sheets. Compact and

portable, it even has automatic on/off. Will fold up to 1500 letters per hour. 115v 60 Hz UL & CSA approved.

Cat#	Description	Price
1400	Instant Letter Folder	\$289.99



# REGULUS®

## TAPER REGUBINDER RB3

This new machine applies durable and decorative tape covering the spine area of books, pads, catalogues, etc... anything that is stit padded or bound can be

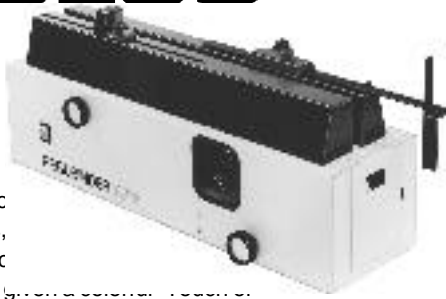

Class." The Regubinder RB3 is of solid and functional construction. Spine-taping is carried out in one operation from right to left. Thickness adjustments range from 3-50mm and up to 420mm in length, applying Regu Self-Adhesive Tapes.

**Cat. # TR-RB** Regubinder RB3 ..... \$2950.00

## REGULUS® BRAND BOOKBINDING TAPE

Regu Spinebinding Tapes unroll easily and are ideal for use by the Regubinder Spinetaper allowing economical application. This unique black tape, with three different embossed finishes available, is used for spinebinding and is coated with a high-tack adhesive resisting aging. All have a structured surface and are offered in many attractive colours. Therefore these tapes are ideal for application to books, brochures, catalogs, notebooks, and any other matter previously glued or stapled.



**REGUTAFH3** Pressure sensitive fibrous paper with slightly embossed surface. 55 yd. rolls: 3" core

Cat. #	Size	Color	Unit/Package	Price
TRA-T1	¾"	Black	8	\$13.24
TRA-T2	1"	Black	6	17.10
TRA-T3	1½"	Black	4	24.00
TRA-T4	2"	Black	3	33.73
TRA-T5	2½"	Black	2	39.66
TRA-T6	3"	Black	2	49.54

**REGU-FLEX** Pressure sensitive acrylic coated paper with attractive leather design. 55 yd. rolls: 3" core

Cat. #	Size	Color	Unit/Package	Price
TRA-F1	¾"	Black	8	\$14.83
TRA-F2	1"	Black	6	18.49
TRA-F3	1½"	Black	4	25.90
TRA-F4	2"	Black	3	36.46
TRA-F5	2½"	Black	2	42.85

**REGUDUX RX** Pressure sensitive, pliable, highly tear resistant plastic tape with linen finish. 55 yd. rolls: 3" core

Cat. #	Size	Color	Unit/Package	Price
TRA-D1	¾"	Black	8	\$16.48
TRA-D2	1"	Black	6	20.86
TRA-D3	1½"	Black	4	31.31
TRA-D4	2"	Black	3	40.53
TRA-D5	2½"	Black	2	49.75
TRA-D6	3"	Black	2	64.79

Quantity Discount: 12 rolls @ 5%, 50 rolls @ 15%  
\*Note other attractive colors in Red, Brown, Green, Blue and White are available upon request. Also available, free color samples.

**CALLPERFECTION FOR AVAILABILITY**

## BANDING PRESS

Solve storage problems, cut shipping costs, decrease shipping damage by compressing and banding paper, forms, computer cards into neat and compact bundles. Maintains up to 1500 lbs. of pressure. Constructed of high-strength cast aluminum alloy and steel.



**Cat. # BA-12** 12" Banding Unit.....\$320.00

**Cat. # BA-18** 18" Banding Unit.....\$355.00

## AUTOMATIC PAPER TAPE STRAPPING MACHINE

### AKEBOND OB-300

#### FEATURES

Broad range of functions. Gently but firmly straps from 30 to 380mm in width.



#### ■ User Friendly Design

Three types of operation, single acting and continuous operation and pause.

#### ■ Firm Strapping of any type of products.

Accommodates various product requirements. Strapping is performed by means of a three stage tightening adjustment to match the merchandise; firm for hard products and gentle for soft products.

#### ■ 15 Seconds "quick start"

You can start just 15 seconds after turning the machine on.

#### ■ Neat Joint

Makes a neat and secure joint through two-point heat deposition and knife cutting.

#### ■ High Safety

Features a safety design. When operation is interrupted for 10 minutes, the heater power automatically turns off.

#### ■ Simple Tape Replacement

The tape is easily loaded into the tape holder and inserted into the guide.

Akebond OB-300 Taping Machine.....\$4,600.00

Akebond OB-300 Brown Paper Tape  
Packed 40-rolls per case (1.2" x 623 feet)

<b>Cat. # TB-300</b>	0-80 rolls	\$8.12/roll
	80 or more	7.10/roll

#### OB-300 Exclusive Tape:

White Tape, Color Tape, Printed Tape and other special specifications are also available upon request.



#### PLASTIC KNIFE GUARD

- Makes transporting knives safe
- Essential for 3-knife trimmers
- Magnetic strip holds guard firmly in place
- Knife tip suspended well above the bottom of the guard

<b>Cat. #</b>	<b>Description</b>	<b>Price</b>
KG-J1	Knife Guard	\$1.50/inch



PERFECTION TYPE INC.

1050 33rd Ave. SE Ste. 1000  
MINNEAPOLIS, MN 55444

1-651-917-8444 1-800-829-4815

# BINDERY Acme, Bostitch, Salco staples, staplers, counters

## STAPLES, Acme

Packed in boxes of 5000 staples For Acme No. 685 (6½) stapler

Cat. #	Series #	Size	Weight	Price
ST-A21	495250 (621)	¼"	Standard*	\$15.61
ST-A22	495251 (622)	⅕"	Standard*	15.87
ST-A23	495152 (623)	⅜"	Standard*	16.88
ST-A24	495153 (624)	7/16"	Standard*	17.31
ST-A25	495154 (625)	½"	Standard*	17.33
ST-A26	495155 (626)	9/16"	Standard*	18.53
ST-A51	496250 (651)	¼"	Medium**	17.41
ST-A53	496252 (653)	⅜"	Medium**	18.21
ST-A55	496254 (655)	½"	Medium**	18.42
ST-A56	496255 (656)	9/16"	Medium**	19.38

\* Standard (.018 x .025) wire \*\* Medium (.018 x .037) wire

**Note:** Series 496 medium wire staples require No. 651 cap and driver (set) \$94.12

For Acme Model 731 (old No. 1)

Cat. #	Series #	Size	Weight	Price
ST-A10	462151 (210)	¼"	Fine*	\$15.18
ST-A11	462152 (211)	⅕"	Fine*	15.61
ST-A12	462153 (212)	⅜"	Fine*	15.87
ST-1X	465251 (1X)	¼"	Standard**	15.34
ST-2X	465252 (2X)	⅕"	Standard**	15.56
ST-3X	465153 (3X)	⅜"	Standard**	15.93
ST-4X	465155 (4X)	½"	Standard**	16.67
ST-5X	465156 (5X)	9/16"	Standard**	21.45

\*Fine (.025 x .021) wire \*\* Standard (.025 x .030) wire

**Note:** 210, 211, 212 are fine round wire staples require No. 210 cap and driver (set) \$87.04

For use in Bostitch head No. E6600B packed in boxes of 5000

Cat. #	Series #	Size	Description	Price
ST-R10	SCCR 19	¼"	Chisel Leg	\$ 5.50
ST-R20	SCCR 19	⅜"	Chisel Leg	7.95

For use in Bostitch heads C6250A, C6200B, E6200B – boxes of 5000

Cat. #	Series #	Size	Description	Price
ST-R30	SCCR 25	¼"	Chisel Leg	\$ 8.95
ST-R40	SCCR 25	⅜"	Chisel Leg	9.65
ST-R50	SCCR 25	½"	Chisel Leg	10.25
ST-R60	SCCR 25	9/16"	Chisel Leg	12.65

**Salco** fine wire interchange staples for use in

Acme, Salco and other model 100E, 101E, R105 and R106 staplers with 66/6-8 head – boxes of 5000

Cat. #	Series #	Size	Description	Price
ST-W26	210/6	¼"	Blue Streak	\$ 3.25
				20+ 3.10
				100+ 2.65
ST-W28	210/8	⅕"	Blue Streak	4.50
				20+ 4.28
				100+ 2.85

For use with same models as above but with a 44/6-8 head

Cat. #	Series #	Size	Description	Price
ST-W46	24/6	¼"	Chisel Leg	\$ 3.95
				20+ 3.75
				100+ 2.50
ST-W48	24/8	⅕"	Chisel Leg	4.55
				20+ 4.32
				100+ 2.90

## ELECTRONIC STAPLERS

Worthy successor of the famed 101E! Fully electronic with "ganging" capability for simultaneous multiple stapling. A truly effective impact control allows clean, tight stapling from 2 to 45 sheets, on equivalent materials. Much more durable stapling heads for high volume production.



Specifications	R106
Throat	4"
Weight	14 lbs.
Length	12"
Height	17¼"
Width (total)	10"
Minimum head separation (Gangster®) pkg. only	2½"
Maximum head separation (Gangster®) pkg. only	27"
Staple load	210
Staples	210/6EBS ¼" 210/8EBS ⅕"



Flat/Saddle Stapler	Gangster Package
Model R106	Model R106
\$420.00	\$915.00

\*Options – Adjustable Floor Stand.....\$150.00

## DIGITAL ELECTRONIC COUNTER



### FEATURES OF BOTH COUNTERS

- No moving parts – all electronic circuitry for the utmost reliability
- Rugged impact resistant case
- Sensor head mounts anywhere on fold plate or register side guide – magnetic cord holder prevents machine from eating cord
- Unaffected by ambient light or dust – sensor uses reflected infra-red light to count passing sheets of paper. Nothing ever touches the stock being run. Sensor head mounts magnetically. Adapters are provided for aluminum fold plates.
- Will not falsely count printed areas or dark lines.
- No holes to drill – No tools needed
- Mounting post, clamp and sensor head included
- Quick and easy to install – Fits most printing and bindery machines

Maximum counting speed – More than 200,000 per hour

Maximum count: 999,999

Size: 5.5" H x 3.5" W x 2.5" D

Sensor Size: 1.5" x 1"

**Cat. # EC-L20 Model 1000A**  
with sensor head & post mount ..... \$259.00

**Cat. # EC-L30 Memory Counter**  
with sensor head & post mount..... \$289.00



DEFLECTION TYPE INC.

1050 33rd Ave. SE Ste. 1000

1-651-917-8444 1-800-829-4815

# LETTERPRESS Matrix, Channel Creases, Shim Tapes

## CHANNEL CREASING MATRIX

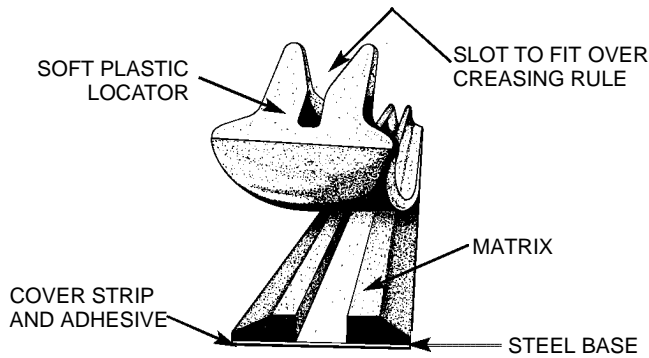

1. Place CHANNEL CREASING MATRIX locator over or between the creasing rule(s)
2. Peel off backing paper protecting adhesive. Put press on impression, completing one cycle. CHANNEL CREASING MATRIX adheres to the cutting plate.
3. As the press completes its cycle, the CHANNEL CREASING MATRIX is released from the die and remains firmly attached to the cutting plate.
4. The plastic locator is stripped away. The matrix is now ready to run in accurate register.

### ORDER GUIDE

Available sizes of CHANNEL CREASING MATRIX are listed below. They are color coded and the range is listed per board thickness. State the number of boxes when ordering.

### CENTER CREASE, 48' PER BOX

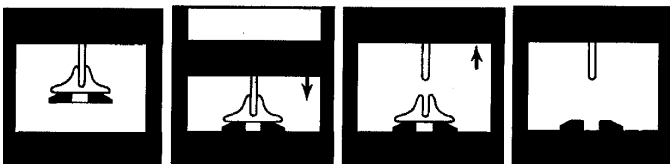
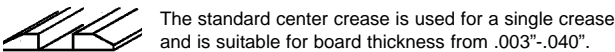

Cat. #	Size	Color	For Boards
CCM-32-1	#32	Orange	.006" & under thick
CCM-40-1	#40	Buff	.006"-.010" thick
CCM-50-1	#50	White	.010"-.015" thick
CCM-60-1	#60	Yellow	.015"-.020" thick
CCM-67-1	#67	Violet	.018"-.021" thick
CCM-75-1	#75	Green	.020"-.025" thick
CCM-83-1	#83	Rose	.026"-.029" thick
CCM-90-1	#90	Red	.025"-.035" thick
CCM-105-1	#105	Blue	.030"-.040" thick
<b>1-5 Boxes</b>	<b>6-11</b>	<b>12+</b>	
\$30.55/ea.	\$29.80/ea.	\$29.10/ea.	

### OFF-CENTER CREASE, 48' PER BOX

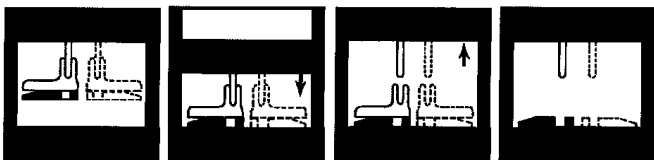
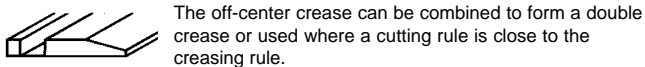

Cat. #	Size	Color	For Boards
CCM-40-OCB	#40	Buff	.006"-.010" thick
CCM-50-OCW	#50	White	.010"-.015" thick
CCM-60-10C	#60	Yellow	.015"-.020" thick
<b>1-5 Boxes</b>	<b>6-11</b>	<b>12+</b>	
\$30.55/ea.	\$29.80/ea.	\$29.10/ea.	

## DOUBLE CREASE, 28' PER BOX

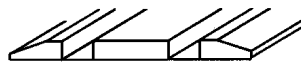

Double crease matrix is used for multiple creases such as file folders and brochures. Center to center dimensions of the channels are 1/8", 3/16", and 1/4".

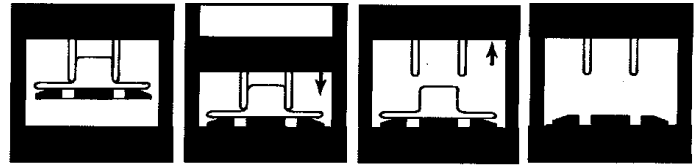

Cat. #	Size	Color	For Boards
CCM-50-DC50%	#50	White	.010"-.015" thick
CCM-50-DC3/16	#50	White	.010"-.015" thick
CCM-50-DC1/4	#50	White	.010"-.015" thick
CCM-60-DC1/4	#60	Yellow	.015"-.020" thick
<b>1-5 Boxes</b>	<b>6-11</b>	<b>12+</b>	
\$30.55/ea.	\$29.80/ea.	\$29.10/ea.	

All one-half inch locator above, is suitable for 2 point rule.

## REVERSE CREASE, 48' PER BOX (2 & 3PT) 28' PER BOX (4 & 6PT)



Reverse crease matrix acts as the male rule and is used to accomplish a crease in reverse. Two rules in the die act as the channel.

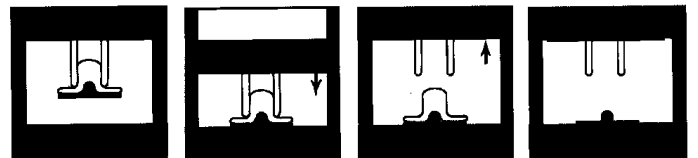

Cat. #	Size	Color	For Boards
CCM-75-R2G	#75	Green	Light Weight
CCM-105-R3B	#105	Blue	Medium Weight
CCM-120-R4B	#120	Brown	Heavy Board
CCM-200-R4B	#200	Brown	Heavy Board
CCM-200-R6B	#200	Black	A-Flute Board
CCM-250-R6B	#250	Black	A-Flute Board
<b>1-5 Boxes</b>	<b>6-11</b>	<b>12+</b>	
\$30.55/ea.	\$29.80/ea.	\$29.10/ea.	

Reverse Crease Matrix was designed to eliminate the need for running a job through the press twice. The most common application of reverse crease is for putting Z-folds or accordian folds in a product.

Take the question out of Matrix selection with our Matrix selector, it is free. Just contact Perfection.

## SHIM TAPES

SHIM TAPES allow rule height adjustments from .0015-.005". For cutting rule and creasing rule place directly over rule of die where extra height is needed.

Cat. #	Description	Length	Price
STS-C15	FIT-.0015 Thick	33 ft.	\$19.15
STS-C02	ACCU-SHIM 2-.002 Thick	33 ft.	10.50
STS-C05	ACCU-SHIM 5-.005 Thick	33 ft.	16.95

## CCM Special Equipment and Supplies

Cat. #	Description	Price
7MPICCOMP	Mitering Bench Press	\$511.90
7MPICCM	Mitre Plier Cutter	95.75
7MPICCMS	Straight Cut Shears	22.00
7MPICCMA	Miter Plier Anvil	3.60
7MPICCMB	Miter Plier Blade	7.75



# LETTERPRESS Cutting, Scoring, Perforating Rule, Rule Cutter, Brushes, Cleaners

## CUTTING RULE

■ Steel, 2 Point Body, 24" strips.  
Price: Each \$1.55 50+ \$1.20 ea.

Cat. #	Bevel	Temper	Height
CU-9HC	Center	Hard	.918
CU-9HS	Side	Hard	.918
CU-9MHC	Center	Medium	.918
CU-9MHS	Side	Medium	.918
CU-9RC	Center	Hard	.937
CU-9RS	Side	Hard	.937

## SCORING RULE

■ Steel, 2 Point Body.  
■ Stocking in Medium Hard Temper.  
Price: 24" Strip Each \$1.55 Each 50+ \$1.20  
36" Strip Each \$2.30 Each 50+ \$1.75

Cat. #	Length	Height	Cat. #	Length	Height
SC-10	36"	.890	SC-20	36"	.909
SC-15	36"	.900	SC-25	24"	.918

## PERFORATING RULE

■ Steel, 2 Point Body, 24 Inch Strips.  
■ Stocking in Centerface, Double Bevel.  
■ All rules have .032 Tie (space between teeth)  
(except 17 tooth, which has .025 tie)  
Price: Each \$3.00 50+ \$2.70 ea 100+ \$2.55 ea.

Cat. #	Teeth/Inch	Height	Cat. #	Teeth/Inch	Height
PR-05	2	.909	PR-35	2	.918
PR-10	3	.909	PR-40	3	.918
PR-15	4	.909	PR-45	4	.918
PR-20	8	.909	PR-50	6	.918
PR-22	10	.909	PR-55	8	.918
PR-25	12	.909	PR-60	10	.918
PR-30	17	.909	PR-65	12	.918
PR-80	8	.937	PR-70	14	.918
PR-85	12	.937	PR-75	17	.918

## "INVISIBLE" PERFORATING RULE

■ Steel, 2 Point Body, 36 Inch Strips.  
■ Teeth are so fine that it gives the appearance of having been cut, rather than perforated.  
Price: Each \$14.85 50+ \$11.90 ea.

Cat. #	Teeth/Inch	Height	Cat. #	Teeth/Inch	Height
PM-30	30	.918	PM-50	50	.918
PM-40	40	.918	PM-70	70	.918

- Coils are available in 150 and 300 ft. lengths or we can have rule cut to any length.
- If the rule you use is not listed above, please phone us and we will explain how we can order any special combination of teeth, tie, bevel, height or thickness made to your specifications.
- Special non-stock rules from factory require minimum order of 300 feet or more.

## STEEL RULE CUTTER

Made of heavy duty construction, will cut steel rules up to 3 points thick with ease. Cutter has two type scales that permit cutting long strips as well as pieces.

Cat. # STS-50	Steel Rule Cutter	\$850.00
Cat. # STS-60	Set of Extra Knives	85.00

## LIBITE TYPE WASH

Instantly penetrates and removes hard, dry ink, varnish, & glaze from type forms, press plates, rollers, blankets, ink fountains, cylinders, and press parts. Litho & letterpressmens favorite for over fifty years.



Cat. #	Unit	Price
LB-1	Gal.	\$13.30
	6+	12.37
LB-5	5/gal	60.00

## SHOPAPRON

Protect Your Clothes and Keep Clean Too! Heavy Duty

Blue Denim, 1 waist pocket, 1 pencil pocket. For general shop use.

Cat. #	Unit	Price
SH-103	Each	\$ 9.50
	12+	9.00

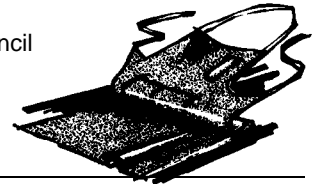

## HOT MELT GLOVES

Feature double layer of heavy nap out fabric over palm, thumb and index finger...Excellent for rough or hot jobs requiring standard protection. All styles feature soft nap out fabric, double layer palm and knuckle strap.

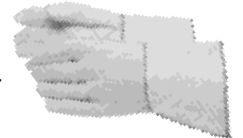

Cat. # GR-24 \$3.75/pair

## BRUSHES

These brushes are used for a wide variety of brushing applications. Each has been designed to perform particular brushing requirements more efficiently. Manufactured with the finest quality materials available, evenly trimmed and ruggedly constructed.



Cat. #	Item	Price
BR-9067	Type Brushes (2 1/8" x 4 3/4")	\$4.50
BR-9121	Brass Plate (2 1/2" x 4 1/4")	5.80
BR-806C	Brass w/hair (2 1/2" x 4 1/4")	8.66
BRS-1806	Stainless Steel (2 1/2" x 4 1/4")	14.50
BR-9067.003	Stainless (.003)bristle (2 1/2" x 4 1/4")	25.76



## NUMBERINGMACHINECLEANERANDLUBRICANT

### CLEANER NO. 909 D-2

CLEANER NO. 909 D-2 is a blend of powerful but nondamaging, nontoxic ink solvents and super-fine lubricants, scientifically formulated to assure clean, smooth-running numbering machines. It eliminates the need to disassemble the unit before cleaning.

Cat. #	Unit	Price
A-NM-7063	Qt.	\$10.65
A-NM-7063	Gal.	\$24.01
	6+	22.33



# LETTERPRESS Gauge Pins, Wax, Perforating Backing, Rollers, Jackets, Slugs

## GAUGE PINS

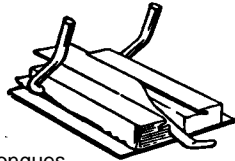

### ADJUSTABLE QUAD GUIDE

Set of 3 includes 3 curved and 3 straight tongues.

Cat. #	Item	Price
GA-AD	Quad Guides	\$14.00 set
GA-AT	Tongues	4.00 doz.

### HOOVER STYLE

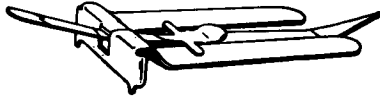

### HEAVYDUTY

Cat. #	Item	Price
GA-HD	Gauge Pins Hoover Heavy Duty	\$15.50 doz.
GA-T1	Hoover Tongues 1"	2.95
GA-T3	Hoover Tongues 1 1/8"	3.75
GA-T4	Hoover Tongues 1 1/4"	4.00
GA-T6	Hoover Tongues 2 1/8"	4.25

### MEGILL® SPRING TONGUE

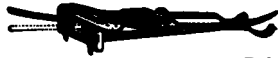

Cat. #	Item	Price
GM-ST	Gauge Pins Spring Tongue	\$18.00 doz.

### MEGILLDOUBLE GRIP

### SOLD IN SETS OF 3



Cat. #	Item	Price
GM-HF	Gauge Pins Double H.F.	\$18.75 set

## SEALING WAX

A quality wax! Flows freely under heat. Used to set gauge pins and has many other uses. Packed 4 sticks in 1 lb. package.

Cat. # SE-6	Ship wt. 1 1/2 lb. per pkg.	\$17.20
-------------	-----------------------------	---------

## PERFORATION BACKING

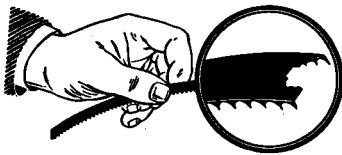

### SABER TOOTH PERFORATING RULE .909 High

\*FOR BEST RESULTS we recommend that our specially-made perforating and cutting rule be used with Saber Tooth Backing. Under type-high, it compensates for the thickness of the backing, eliminating makeready. Saves the rollers, and it costs no more than ordinary rule. Backing 15 ft. Rolls.

Cat. #	Item	Price
S-701	1/8" Saber Backing	\$8.75/roll
S-702	1/4" Saber Backing	8.75/roll

### PERF-A-BASE 40 ft. coil (glues to tympan).

Cat. #	Item	Price
PB-10	10 pt. Perf-A-Base 1/8"	\$19.30/roll
PB-18	18 pt. Perf-A-Base 1/4"	19.30/roll
PB-2	2 oz. Adhesive Perf-A-Base	3.60/bottle
PB-8	18 oz. Adhesive Perf-A-Base	6.50/bottle

## RUBBER LETTERPRESS ROLLERS



Rubber letterpress rollers will outlast composition rollers five to one and are furnished ready to use complete with steel cores. Another important factor about rubber rollers is that they are impervious to heat and climatic conditions and resist shrinking and swelling.

### READY TO USE ROLLERS

Cat. #	Press Model	Price/Ea.
R-CP10	C & P 6 1/2 x 10	\$ 110.00
R-CP12	C & P 8 x 12	110.00
R-CP15	C & P 10 x 15	125.00
R-CP18	C & P 12 x 18	140.60
R-CR15	Craftsman 10 x 15	125.00
R-CR18	Craftsman 12 x 18	141.60
R-H15	Heidelberg 10 x 15	144.00
R-K15	Kluge 10 x 15	125.00
R-K18	Kluge 12 x 18	141.60
R-M50	Meihle V50, 45, 36*	146.60

## STEEL DIE CUTTING JACKETS FOR CYLINDER PRESSES

Jackets have replaceable nylon "shirt tail". They mount and reel on press cylinder same as paper tympan. Standard jacket has hardness of 18 Rc and thickness of .030"... depending on the press.

Boxmaker jacket has hardness of 35 Rc.

Available in thickness of .030" to .060" depending on press and height of cutting rule.

Make & Model	Standard	Boxmaker
Vertical V-36-45	\$160.40	\$283.20
Vertical V-50	160.40	283.20
Miller 21 x 28 SW	307.00	503.10
Miller 21 x 28 TW	307.00	503.10

C & P and KLUGE SNAP ON JACKETS, Specify Make & Size  
**8 x 12** - \$177.65    **10 x 15** - \$183.30    **12 x 18** - \$190.58

HEIDELBERG PLATEN JACKETS - .030" (0.762mm)  
**10 x 15** - T & TP(26 x 38cm)    \$178.40  
**13 x 18** - GT(34 x 46cm)    195.15

### HEIDELBERG OFFSET IMPRESSION JACKETS

GTO - KOR - KORA - KORD - KORS

HEIDELBERG SHIRT TAIL CYLINDER JACKETS - .030"

## PAPER SUPPLIES

Quality Letterpress Tympan Paper in sheets and rolls are available in standard thickness of .006. Per request for Chandler and Price, Miehle, Kluge, Miller and Heidelberg Presses, call for pricing.

## LEADS AND SLUGS

Strip spacing material (accept 1/2 pt.) is made from linotype metal and is accurately casted to insure trouble free lock-up.

Cat. #	Description	Length	Price
BR-100	1/2 pt. Copper Leads	24"	\$ 3.30 ea.
MT-2	2 pt. Leads	24"	2.75 lb.
MT-3	3 pt. Leads	24"	2.75 lb.
MT-6	6 pt. Slugs	24"	2.75 lb.
MT-L12	12 pt. Slugs	24"	2.75 lb.



# LETTERPRESS Tweezers, Brayers, Furniture, Quoins, Blades, Knives

## PRINTERS TWEEZERS

All tweezers nickel plated and solidly constructed.



**Cat. #** TW-330      **Item** Regular Shim in Head 4 1/2"      **Price** \$ 5.30



**Cat. #** TW-430      **Item** Narrow 4 1/2"      **Price** \$ 5.50

## MAGNET LOCKS

1/2" x 1 1/4" x 5/8" price each \$5.50

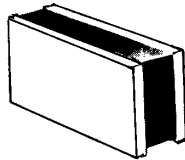

**Cat. #** M-1      **Item** Box of 10 \$5.00 ea.  
Box of 25 4.00 ea.

## INKBRAYER

**Cat. #** BR-4174      **Item** 4" Soft Rubber      **Price** \$12.80  
BR-66      6" Soft Rubber      13.75

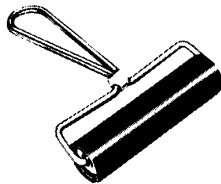

## HEAVY DUTY PROFESSIONAL BRAYER

Our new precision ground neoprene rubber roller will outlast the old type cast composition roller 15 to 1. Comes with extra sturdy one-piece cast aluminum frame.



**Cat. #.** BR-10C      **Item** 10" Heavy Duty Aluminum Brayer      **Price** \$72.00

## HI-SPEED CLICKTITE® QUOIN KEY

The first fool-proof quoin key in the history of printing...CLICKS WHEN TIGHT!

The new patented clicktite key with a spring loaded dog-clutch drive allows all quoins to be tightened to a uniform predetermined tension of 650 lbs. pressure, insuring perfect, uniform lock up. Any turning after the pre-set point, the key handle simply "clicks" harmlessly around the shaft.



**Cat. #** Q-200W      **Item** Hi-Speed Clicktite Quoin Key      **Price** \$77.50  
Q-200WR      Clicktite Replacement Insert      9.40

## HI-SPEED QUOIN KEY

**Cat. #** Q-200      **Item** Tee Head Hi-Speed Quoin Key (One piece)      **Price** \$29.40  
Ship. wt. 8 oz.



**Cat. #** Q-300      **Item** Pressman's right angle high speed quoin key      **Price** \$30.00



## HI-SPEED QUOINS and KEYS

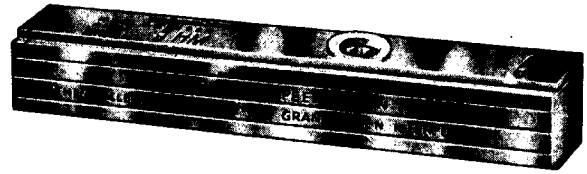

All sizes except 3-inch have lock and register marks. Height 0.719.

Cat. #	Length	Net Wt.	1-11	12-60
Q-03	3 inches	8 oz.	\$48.50	\$46.00
Q-06	6 inches	1 lb.	51.50	48.90
Q-09	9 inches	1 1/2 lb.	56.75	53.90

## FURNITURE

Wood, Cabinet and Contents.

No. 13728-B Furniture Cabinet. Overall dimensions, 9 3/4" x 10 5/8" x 32 1/2" high. Holds 280 pcs. 10 to 60 ems (280 pcs.) Widths - 2, 3, 4, 5, 6, 8 and 10 picas. Lengths - 10, 15, 20, 25, 30, 40, 50 and 60 picas.

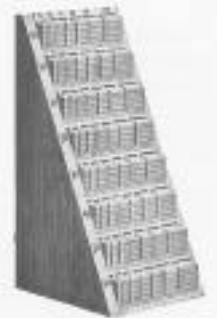

Cat. #	Item	Price
13728-B	Cabinet only	\$260.00
13728-A	Furniture only	160.00
13728	Cabinet & contents	390.00

## FURNITURE and REGLET

Hamilton, Wood

36-inch Strips Regular (5/8 in. high) Birchwood

Cat. #	Size	Price Ea.
WD-R06	6 Point	\$ 0.75
WD-R12	12 Point	0.80
WD-R18	18 Point	0.90
WF-02	2 Pica	1.05
WF-03	3 Pica	1.20
WF-04	4 Pica	1.50
WF-05	5 Pica	1.90
WF-06	6 Pica	2.25
WF-08	8 Pica	2.75
WF-10	10 Pica	3.50
WF-12	12 Pica	4.00

## RAZOR BLADES

The finest quality in industrial single edge blades. Ideal for a hundred cutting uses.



**Cat. #** RA-B      **Item** Box of 100 Blades      **Price** \$9.80

## LAMSON INK KNIVES



Cat. #	Item	Price
INK-4	4" Blade, 1 1/2" wide	\$14.00
INK-6	6" Blade, 1 5/8" wide	16.00
INK-8	8" Blade, 2 1/16" wide	19.00
INK-10	10" Blade, 2 3/16" wide	21.00
INK-12	12" Blade, 3 1/16" wide	22.00



## PRINTERS LINE GAUGES

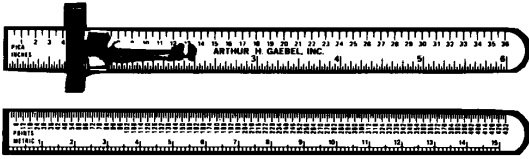

**611-C** This is a 6" pocket ruler that comes with a clip. It has a pica/half-pica scale on the front top and inches graduated in 16ths on the bottom. On the back top edge there is a point scale and on the bottom a metric scale. The start is flush on this useful tool.

Cat. #	Rule # & Length	Price
LG-65	611C-6"	\$3.50



**612** This two-sided ruler comes in 6", 7", 12", 18" & 24". The front has 6 & 12 point and inches (16th) while the back has 6 & 12 point and agate lines.

Cat. #	Rule # & Length	Price
LG-06	612-6"	\$6.75
LG-07	612-7"	6.75
LG-10	612-12"	6.95
LG-15	612-18"	8.95
LG-30	612-24"	11.95



**612-A** Two-sided ruler in 12" only. The front has 6 & 12 point and 8 point marks while the back has inches (16th) and 10 point scales.

Cat. #	Rule # & Length	Price
LG-32	612A-12"	\$6.95

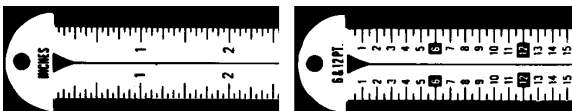

**612-B** Two-sided ruler in 12" only. The front has inches left and right and the back has 6 & 12 point left and right.

Cat. #	Rule # & Length	Price
LG-20	612B-12"	\$6.95



**612-C** Two-sided line gauge in 12" only. The front has Ciceros and metric while the back has picas and inches.

Cat. #	Rule # & Length	Price
LG-21	612C-12"	\$6.95



**612-E** This line gauge is again two-sided and only comes in 12". It has picas & inches on the front and metric and agate lines on the back.

Cat. #	Rule # & Length	Price
LG-23	612E-12"	\$6.95

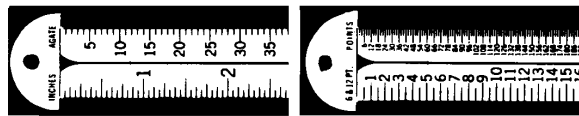

**612-F** Another very popular two-sided ruler in 12", 18", & 24". The front has inches & agate line markings while the back has 6 & 12 point (picas) & points.

Cat. #	Rule # & Length	Price
LG-24	612F-12"	\$6.95
LG-25	612F-18"	8.95
LG-26	612F-24"	11.95

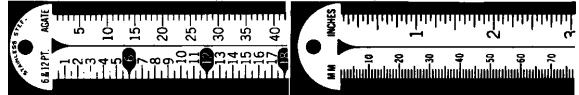

**612-G** This two-sided ruler is in 12", 18", & 24" lengths. The front has 6 & 12 point and agate lines and the back has millimeters and inches.

Cat. #	Rule # & Length	Price
LG-27	612G-12"	\$6.95
LG-28	612G-18"	8.95
LG-30	612G-24"	11.95



**612-H** Two-sided 12", 18", & 24" ruler. Has 6 & 12 point on the front left and inches on the right. Back has metric & inches.

Cat. #	Rule # & Length	Price
LG-32	612H-12"	\$6.95
LG-34	612H-18"	8.95
LG-36	612H-24"	11.95



**614** Two-sided ruler in 12" only. The front has 6 & 12 point and inches (16ths) while the back has 8 & 10 point.

Cat. #	Rule # & Length	Price
LG-38	614-12"	\$6.95



**614-A** This 12" ruler is identical to the 614 above except the front has 2 and 12 point with inches. The back is the same.

Cat. #	Rule # & Length	Price
LG-39	614A-12"	\$6.95

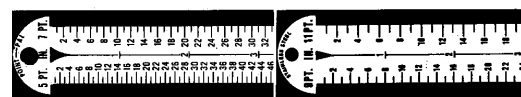

**614-B** This two-sided 12" ruler consists of all point markings. The front has 5 and 7 point and the back has 8 and 11 point.

Cat. #	Rule # & Length	Price
LG-40	614B-12"	\$6.95





# LETTERPRESS

Line Gauges, Micrometer, Thickness Gauge, Magnifiers, Soap

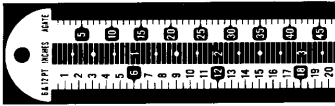

**712** This ruler is one sided and comes in two sizes: 12" & 18". The left scale is in 6 & 12 point, the middle is inches, and the right has agate lines.

Cat. #	Rule # & Length	Price
LG-42	712-12"	\$5.95
LG-44	712-18"	7.95

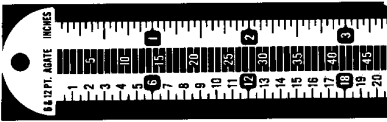

**713** Another one-sided ruler in 12" & 18". The left has 6 & 12 point, the middle has agate lines and the right is in inches.

Cat. #	Rule # & Length	Price
LG-45	713-12"	\$6.75
LG-55	713-18"	8.75

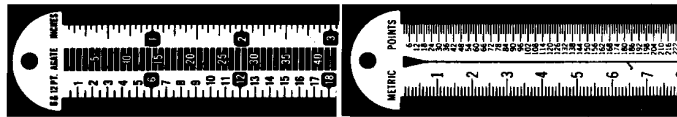

**713-2** This two-sided ruler is available in 12" & 18". It has three markings on the front: 6 & 12 point, agate and inches. The back has only two: metric and points.

Cat. #	Rule # & Length	Price
LG-50	713/2-12"	\$6.75
LG-52	713/2-18"	8.95

## DIAL MICROMETER

This fine quality measuring tool is perfect for the professional who needs precision on the job. The frame is precision cast, aluminum alloy contoured to fit comfortably in your hand. Dial has sharp, well defined graduations for unmistakable direct readings through clear, unbreakable crystal. The spindle moves in very precise bearings, so the flat, .250" diameter contacts maintain parallelism accuracy. Complete with padded carrying case.



**Cat. # MX-252** .....\$193.15

## ENCO DIAL THICKNESS GAUGE

Measure paper, film, flatstock.

- 0 to 0.400" range.
- 0.001" graduations.
- 1.0" throat clearance.



**Cat. # MX-254**.....\$86.50

## LINEN TESTER 6-POWER

Precision made pocket magnifier with fixed focus glass. Uniform and precise 6-power enlargement.



**Cat. # LL-387**  
Complete with case  
\$10.90

## MAGNIFIER

These are the most popular style magnifiers in the graphic arts field and are ideal for close examination. The Achromatic three element lens systems assures a clear sharp image from the center to the edge of the wide flat field. The locking focus is adjustable. They come with a vinyl case.



Cat. #	Power	Price
L723-S	12X	\$49.00
L723-B	15X	64.00
L723-C	22X	78.00

## ACCELL COMPOUND X ROLLER PASTE

Compound X deglazes and deep cleans rubber ink rollers to remove contaminants, ink, etc.



Cat. #	Unit	Price
R-208	8 oz tub	\$8.00 ea
R-300	2 lb tub	30.00 ea
	8 or more	23.00 ea

## CRA-Z SOAP

Out performs leading paste hand cleaners and last as long as two gallons of paste hand cleaners!



Cat. #	Description	Price
P-9	9 oz. bar	\$7.75 ea

## KRESTO® EF®

The Hand Cleaner For Extra Heavy Dirt

- Unsurpassed Cleaning
- Up to 50% Less Solvent
- Contains EUCORNOL® to Condition
- Ideal for:
  - Grease and Grime
  - Printing Ink
  - Graphite/Carbon Black
  - Sealants/Silicones
  - Asphalt and Tar

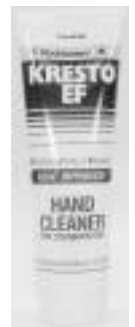

Cat.#	Description	Price
28700524	8.5 oz. Tube	\$3.50



DEFLECTION TYPE INC

1050 33rd Ave. SE Ste. 1000  
MINNEAPOLIS, MN 55454

1-651-917-8444 1-800-829-4815

# LETTERPRESS      Numbering Machines

**BIMATIC** – reversible, backward or forward numbering in one machine.

**BIMATIC ACTUALSIZE SAMPLES**

**CRASH**      No 123456  
**GOthic**    No 123456  
**ROMAN**    No 123456



SIZE: 4¼ x 8½ picas, 1¼ figures

Cat. #	Style	Model	No. Wheels	Price
NU-BG	Gothic	Standard	6	\$156.00
NU-BR	Roman	Standard	6	156.00
NU-BGA	Gothic	Crash	6	156.00
NU-HG	Gothic	Low Plunger	6	156.00
NU-HR	Roman	Low Plunger	6	156.00

\*Note 7 wheel machines available per request

**NUMBERING MACHINES, Typographic**

**Standard** – for use on platen and other presses with reciprocal motion and presses operating at moderate speeds.

**Lock Pawl** – *lock-wheel model* for use on Miehle Vertical and other high speed presses.

**Low Plunger** – *lock-wheel, low plunger model* for use on Heidelberg Cylinders and other cylinder presses requiring a low plunger stroke (.040" - .047" plunger rise).

**MODEL 12**

ROMAN      5/32" character height  
**No 567890**  
 CASE SIZE  
 GOTHIC    4½ x 8½ Picas  
**No 567890**      (.747" x 1.420")



Cat. #	Style	Model	No. Wheels	Price
NU-12B	Backward Gothic	Standard	6	\$110.00
NU-12F	Forward Gothic	Standard	6	110.00
NU-12BR	Backward Roman	Standard	6	110.00
NU-12FR	Forward Roman	Standard	6	110.00
NU-12LB	Backward Gothic	Lock Pawl	6	115.00
NU-12LF	Forward Gothic	Lock Pawl	6	115.00
NU-12LBR	Backward Roman	Lock Pawl	6	115.00
NU-12LFR	Forward Roman	Lock Pawl	6	115.00
NU-12SB	Backward Gothic	Low Plunger	6	120.00
NU-12SF	Forward Gothic	Low Plunger	6	120.00
NU-12SBR	Backward Roman	Low Plunger	6	120.00
NU-12SFR	Forward Roman	Low Plunger	6	120.00

\*Note 7, 8 and 10 wheel models are available per request, call for pricing.  
 (6 wheels = 4½ x 8½ picas)

**NUMBERING MACHINES, continued**

**MODEL 24**

1/8" character height  
 Ideal for use in limited space.

ROMAN  
**No 123456**  
 CASE SIZE  
 3½ x 6½ Picas  
 (.580" x 1.085")  
 GOTHIC  
**No 123456**

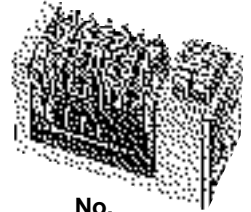

Cat. #	Style	Model	No. Wheels	Price
NU-24B	Backward Gothic	Standard	6	\$120.00
NU-24F	Forward Gothic	Standard	6	120.00
NU-24BR	Backward Roman	Standard	6	120.00
NU-24FR	Forward Roman	Standard	6	120.00
NU-24LB	Backward Gothic	Lock Pawl	6	125.00
NU-24LF	Forward Gothic	Lock Pawl	6	125.00
NU-24LBR	Backward Roman	Lock Pawl	6	125.00
NU-24LFR	Forward Roman	Lock Pawl	6	125.00
NU-24SB	Backward Gothic	Low Plunger	6	130.00
NU-24SF	Forward Gothic	Low Plunger	6	130.00
NU-24SBR	Backward Roman	Low Plunger	6	130.00
NU-24SFR	Forward Roman	Low Plunger	6	130.00

\*Note 7, 8 and 10 wheel models are available per request, call for pricing.  
 (6 wheels = 3½ x 6½ picas)

**MODEL 50**

ROMAN      3/16" character height  
**No 123456**  
 CASE SIZE  
 GOTHIC    5½ x 10 Picas  
**No 123456**      (.890 x 1.665")

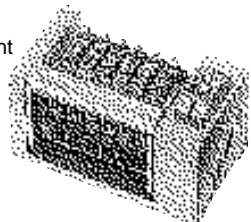

Cat. #	Style	Model	No. Wheels	Price
NU-50B	Backward Gothic	Standard	6	\$140.00
NU-50F	Forward Gothic	Standard	6	140.00
NU-50BR	Backward Roman	Standard	6	140.00
NU-50FR	Forward Roman	Standard	6	140.00
NU-51B	Backward Gothic	Lock Pawl	6	150.00
NU-51F	Forward Gothic	Lock Pawl	6	150.00
NU-51BR	Backward Roman	Lock Pawl	6	150.00
NU-51FR	Forward Roman	Lock Pawl	6	150.00
NU-52B	Backward Gothic	Low Plunger	6	160.00
NU-52F	Forward Gothic	Low Plunger	6	160.00
NU-52BR	Backward Roman	Low Plunger	6	160.00
NU-52FR	Forward Roman	Low Plunger	6	160.00

\*Note 7, 8 and 10 wheel models are available per request, call for pricing.  
 (6 wheels = 5½ x 10 picas)



**ANTI-OFFSET POWDERS**

Electro Sprayer powders are specially processed so that particle adherence between the starch granules is practically eliminated. Regardless of your ambient humidity, the powders will not cake or clog. This means that Electro Sprayer powders will always be free flowing; less build-up on tubes or nozzles; and less dropping on the sheet or web. This free flowing quality assures you of even powder dispersion for maximum offset production.

Cat. #	ESS #	Micron Size	Unit/Price
SP-29	29	15-20	10 lb./29.65
SPX-29			50 lb./78.72

Very fine powder for use on smaller presses with lower piles. Ideal on smooth stock and light paper. Leaves smooth finish.

Cat. #	ESS #	Micron Size	Unit/Price
SP-35	35	20-23	10 lb./29.26
SPX-35			50 lb./78.72

Most popular powder for regular and coated label paper stock. For use on medium size presses with medium piles.

Cat. #	ESS #	Micron Size	Unit/Price
SP-50	50	24-27	10 lb./30.61
SPX-50			50 lb./85.08

Medium fine powder recommended for heavier stock like label, book covers and light carton. Ideal for use in film packaging and heavy ink/varnish coverage.

Cat. #	ESS #	Micron Size	Unit/Price
SP-65	65	34-38	10 lb./31.36
SPX-65			50 lb./87.79

Medium powder is recommended for heavy ink/varnish coverage on large presses where stock is piled to full loads. Generally for stock smooth on one side.

Cat. #	ESS #	Micron Size	Unit/Price
SP-75	75	50-55	10 lb./33.59
SPX-75			50 lb./89.74

A course powder for folding carton work with full loads, uneven stock on both sides. Sulfite board, SBS, ice cream and cereal cartons.

**PLASTIC PILE SEPARATORS**

3 – Sizes for All Presses

- Give accurate leveling of stock pile
- For Feeder End to assure positive pickup
- For Delivery End to assure positive pickup



Assure level stock pile for feeder suckers. Having a longer taper than wooden wedges, they permit closer adjustment and prevent misses and dragging, folding under, etc.

- (A) 8-inches long, wide with low angle of raise.  
Cat. # PR-A..... \$4.90/ea.
- (B) 6-inches long, narrow with high angle of raise.  
Cat. # PR-B..... \$2.40/ea.
- (C) 4¾" long, medium width, low angle of raise.  
Cat. # PR-C..... \$2.55/ea.



**SPRAY POWDERS**

■ **Anti-Static Control** - An additive minimizes powder from collecting inside hoses and connectors. No other spray powder offers this formulation. This additive enables press operators to spray less powder with even distribution onto each sheet, and minimizes clogging in the powder system.

■ **Quality Control** - The consistency of the micron range is 20-23 for general purpose printing. No other powder manufacturer screens powder to assure this range of quality.

■ **FDAApproved - Airtech®** powder has passed government tests required for FDA certification and is guaranteed against health risks ensuring press operator safety.

■ **Powder Packets** - All Airtech® powder is individually packaged in 5 ounce bags. This packaging makes it easy to refill powder jars, and prevents moisture, oil, dirt and dust from contaminating the powder.

Cat. #	Description	Price
SPX-A25	Spray Powder, 5lbs (16-5 oz. bags) 25 micron	\$25.00/box

**PRESS ROOM GLOVES**

PVC gloves are excellent for the really tough jobs. PVC is compatible with most chemicals; acids, caustics, alcohols and solvents. These blue gloves are 12" long and are of excellent quality.



Cat. # GP-611..... \$6.05/pr.

**TEXTURED DISPOSABLE GLOVES**

These gloves are made of unusually soft and pliable virgin polyethylene that are chemical resistant, also textured to provide a more positive grip when wet. Are cooler to wear for long periods of time. The gloves come in a pop-up dispenser box. (100 per box) Large Size



Cat. GP-8678..... \$12.95/box

**SOLVENT SQUIRTERS**

■ **LUBE-ALLOILERS**  
For those hard to reach spots.  
On-off spout.

Cat. #	Item	Price
LU-4	4-oz. capacity oiler	\$4.95 ea.
LU-2	2-oz. capacity oiler	3.95 ea.



■ **FOR SOLVENTS – PINTS**

Cat. #	Item	Price
SM-11	Solvent squirters/spout	\$4.75/pt.





**COTTON PADS**

These familiar 4" x 4" pads have been an industry standard for years, and for good reason. They have all the properties WEBRIL material is known for in size convenient for many small press and plate making operations. Also great in the camera room and stripping areas.

- 100% pure cotton
- No binders or chemicals
- Excellent wet strength
- Will not scratch

Cat. #	Size	Pieces Per Pkg.	20 Pkgs. Per Case	Less Than Full Case
CT-44	4" x 4"	100	\$79.80	\$4.20/pkg.

**REINER**



**Automatic Numbering Machines**

- **5 Movements:** repeat, consecutive, 2X, 3X, and 4X.
- **Strong Die Cast Frame:** Nickled and highly finished. Plastic handle, smooth and comfortable to use.
- **Figure and letter wheels** of special alloy, strong as steel, drop zeros std.
- **Self Inking** with a pre-inked cartridge good for thousands of impressions.

All 6 & 7 wheel models use the Type 1 **COLORBOX**. A Pre-inked Cartridge good for thousands of impressions. Available with black or red ink. Easy to insert.

Cat. #	Sample Style	Size	Wheels	Price
N-R316	567890	3/16"	6	\$178.00
N-R317	567890	3/16"	6	178.00
N-R732	123456	7/32"	6	190.00
N-R733	123456	7/32"	6	190.00
N-R18	123456	1/8"	6	200.00
N-R18/7	1234567	1/8"	7	273.00
N-R19	123456	1/8"	6	200.00
N-R19/7	1234567	1/8"	7	273.00
N-R318	1234567	3/16"	7	212.00
N-R319	1234567	3/16"	7	212.00
N-R732/7	1234567	7/32"	7	273.00

**INK PADS**

O.E.M. pre-inked pads with holder for std. 6 wheel electronic numbering machines.

Cat. #	Manufacturer	Color	Price Ea.
IN-KB	Count	Black	\$ 6.70
IN-KR	Count	Red	6.70
IN-WB	G-Whiz & Reiner	Black	7.00
IN-WR	G-Whiz & Reiner	Red	7.00

**MULTI-LAMP**



Adjustable Goose Neck Lamp basically designed for delivery units on small Ryobi presses.

Cat.#	Description	Price
VL-18PH	Delivery Lamp (Gray)	\$31.65

**FAST-ALIGN RULER**

The Rules Have Changed



The **FastAlign Ruler** is a revolutionary innovation in printing make ready. This hand-held clear plastic ruler has a unique layout grid that makes setting up a job quick and easy. Just slide a printed sample into a **FastAlign Ruler** and immediately see if it's straight, centered and in position. It's like having a hand held T-square and light table at your press.

Cat.#	Description	Size	Price
RU-S	Small	4" x 13"	\$19.95
RU-L	Large	6" x 19"	40.00

**VERASORB™ ABSORBENT SOCKS**



- Keeps plant clean & safe
- Quick, easy way to clean up leaks & spills
- Absorbs up to 10 times its weight in fluids
- Contains no airborne particles that could damage or scratch plates, rollers, or press equipment.



Keep your plant clean and safe. Verasorb Absorbant Socks are a quick and easy way to clean up all types of leaks and spills. These extra-absorbent, micro capillary action socks are designed to absorb an enormous amount of fluids.

Cat. #	Description	Price
VAS-38	3"x38" Packaged 24 socks	\$44.20/case
VAS-48	3"x48" Packaged 24 socks	58.90/case



# RAPIDTEC

## IMAGEMASTER BLANKETS

A premium compressible blanket for sheet or web fed presses. The blemish-free surface is compounded to allow excellent print fidelity and quick release to enhance sharpness. The carcass is constructed to ensure minimum stretch and maximum resistance to solvents and smashes. Recommended for all paper substrates.

Cat. # Press Blanket Size Ply P S Bar Price

Cat. #	Press	Blanket Size	Ply	P	S	Bar	Price
<b>A.B. Dick</b>							
BL-101	350	15 <sup>3</sup> / <sub>16</sub> " x 10 <sup>1</sup> / <sub>16</sub> "	3		X		\$16.45
BL-102	360	18 <sup>5</sup> / <sub>16</sub> " x 10 <sup>5</sup> / <sub>16</sub> "	3	X			\$21.65
BL-103	360	18 <sup>5</sup> / <sub>16</sub> " x 11"	3	X			22.25
BL-104	375	18 <sup>5</sup> / <sub>16</sub> " x 12 <sup>3</sup> / <sub>16</sub> "	3	X			25.15
BL-105	380	15 <sup>1</sup> / <sub>16</sub> " x 20 <sup>1</sup> / <sub>4</sub> "	3	X			34.73
BL-106	385	18 <sup>3</sup> / <sub>4</sub> " x 22 <sup>1</sup> / <sub>2</sub> "	3	X			43.50
BL-108	9840	19 <sup>3</sup> / <sub>16</sub> " x 12 <sup>5</sup> / <sub>16</sub> "	3	X			26.50
BL-109	9880	19 <sup>1</sup> / <sub>2</sub> " x 22 <sup>3</sup> / <sub>4</sub> "	3	X			47.70
<b>A.M. Multilith</b>							
BL-112	1250	15 <sup>3</sup> / <sub>16</sub> " x 10 <sup>1</sup> / <sub>16</sub> "	3		X		16.70
BL-112W	1250L.W.	18 <sup>7</sup> / <sub>16</sub> " x 11"	3	X			21.80
BL-113	1300,1360,1650	18 <sup>7</sup> / <sub>16</sub> " x 12 <sup>5</sup> / <sub>16</sub> "	3	X			25.05
BL-115	1850	16 <sup>1</sup> / <sub>16</sub> " x 17 <sup>5</sup> / <sub>16</sub> "	3	X			30.95
<b>A.T.F.</b>							
BL-118	Chief 15	15 <sup>3</sup> / <sub>16</sub> " x 10 <sup>1</sup> / <sub>16</sub> "	3	X			16.60
BL-119	Chief 17	18 <sup>5</sup> / <sub>16</sub> " x 10 <sup>3</sup> / <sub>32</sub> "	3	X			21.55
BL-120R	2117, 2217	19 <sup>1</sup> / <sub>16</sub> " x 12 <sup>5</sup> / <sub>16</sub> "	3	X			27.35
<b>Davidson</b>							
BL-121	221	15 <sup>1</sup> / <sub>4</sub> " x 10"	3	X			16.40
BL-123	233, 700, 720	16" x 17 <sup>1</sup> / <sub>4</sub> "	3	X			29.70
BL-124	241, 400, 500	16" x 10"	3	X			17.50
BL-126	600	13 <sup>3</sup> / <sub>16</sub> " x 17 <sup>1</sup> / <sub>4</sub> "	3	X			24.45
<b>Didde</b>							
BL-129	717-040	9 <sup>1</sup> / <sub>32</sub> " x 13 <sup>1</sup> / <sub>2</sub> "	2				12.55
BL-133	723-589	12" x 17 <sup>1</sup> / <sub>2</sub> "	2				18.00
<b>Gestetner</b>							
BL-140	303	18 <sup>1</sup> / <sub>2</sub> " x 12 <sup>5</sup> / <sub>16</sub> "	3	X			23.10
<b>Hamada</b>							
BL-144	500, 550CD	16 <sup>3</sup> / <sub>8</sub> " x 10 <sup>5</sup> / <sub>16</sub> "	3	X			18.70
BL-145	500, 550CDA	16 <sup>1</sup> / <sub>2</sub> " x 11 <sup>1</sup> / <sub>16</sub> "	3	X			21.20
BL-146	600, 660CD	19 <sup>5</sup> / <sub>16</sub> " x 11 <sup>3</sup> / <sub>16</sub> "	3	X			24.70
BL-147	601, 602	19 <sup>3</sup> / <sub>8</sub> " x 12"	3	X			25.00
BL-149	700, 700CD	16 <sup>3</sup> / <sub>8</sub> " x 18 <sup>5</sup> / <sub>16</sub> "	3	X			32.35
BL-149X	800, 880DX,SX	16 <sup>3</sup> / <sub>8</sub> " x 20 <sup>1</sup> / <sub>2</sub> "	3	X			36.10
<b>Ryobi</b>							
BL-169	2700	18 <sup>1</sup> / <sub>32</sub> " x 10 <sup>5</sup> / <sub>16</sub> "	5	X			29.00
BL-170	2800	18 <sup>1</sup> / <sub>16</sub> " x 11 <sup>1</sup> / <sub>4</sub> "	5	X			30.00
BL-171	2800XL	19 <sup>1</sup> / <sub>2</sub> " x 11 <sup>1</sup> / <sub>4</sub> "	5	X			37.50
BL-172	480, 500	16 <sup>3</sup> / <sub>8</sub> " x 19 <sup>5</sup> / <sub>16</sub> "	5	X			55.15
BL-173	3200	18 <sup>1</sup> / <sub>16</sub> " x 12"	5	X			38.85
BL-175	3200LC	19 <sup>1</sup> / <sub>2</sub> " x 12"	5	X			40.00
BL-176	3200MCD/LC	19 <sup>1</sup> / <sub>2</sub> " x 13"	5	X			43.35
BL-177	3200PFA	19 <sup>3</sup> / <sub>16</sub> " x 12 <sup>1</sup> / <sub>4</sub> "	4			X	45.95
BL-180	3302	19 <sup>1</sup> / <sub>2</sub> " x 13 <sup>5</sup> / <sub>16</sub> "	5			X	49.10
BL-182	512	20 <sup>3</sup> / <sub>8</sub> " x 16"	4		X		41.00
BL-183	520	21 <sup>1</sup> / <sub>64</sub> " x 17 <sup>1</sup> / <sub>64</sub> "	4			X	51.40

## BLANKETS



ORIGINAL (O.E.M.)  
BLANKETS FOR RYOBI®  
PRESSES

Cat. #	Press	Blanket Size	Ply	P	S	Bar	Price
BL-169W	2700	18 <sup>1</sup> / <sub>32</sub> " x 10 <sup>5</sup> / <sub>16</sub> "	5	X			\$83.80
BL-170W	2800	18 <sup>1</sup> / <sub>16</sub> " x 11 <sup>1</sup> / <sub>4</sub> "	5	X			84.65
BL-171W	2800XL	19 <sup>1</sup> / <sub>2</sub> " x 11 <sup>1</sup> / <sub>4</sub> "	5	X			91.10
BL-173W	3200	18 <sup>1</sup> / <sub>16</sub> " x 12"	5	X			94.05
BL-176W	3200MCD/LC	19 <sup>1</sup> / <sub>2</sub> " x 13"	5	X			108.75
BL-177W	3200PFA	19 <sup>3</sup> / <sub>16</sub> " x 12 <sup>1</sup> / <sub>4</sub> "	4			X	105.80
BL-180W	3302	19 <sup>1</sup> / <sub>2</sub> " x 13 <sup>5</sup> / <sub>16</sub> "	4			X	112.00
BL-180X	3302	17 <sup>1</sup> / <sub>32</sub> " x 13"	1				44.10
BL-182W	512	20 <sup>3</sup> / <sub>16</sub> " x 16"	4		X		98.60
BL-182X	512	19 <sup>1</sup> / <sub>8</sub> " x 15"	1		X		50.05
BL-183WB	520	21 <sup>1</sup> / <sub>64</sub> " x 17 <sup>1</sup> / <sub>64</sub> "	4			X	160.15

## VITENE BLANKET SAVER

Fast method of restoring low spots on rubber blankets. Fast repuffing brings back to original height and texture. Applicator brush built into cap.

Cat#	Description	Price
BEL-V	4-oz Bottle. ....	\$10.15

## OFFSET PLATE PUNCH NEW! IMPROVED!

Punches paper, polyester and metal offset plates.

Model OP/25 for plates up to 12<sup>1</sup>/<sub>2</sub>", 25 pins, 1/2" center to center, pin bar

Cat. # PS-25..... \$282.00



## SLICK 50® Delivery Chain Self-Cleaning Lubricant

- Dissolves Powder Build-Up Instantly
- Lubricates Chain and Brushes
- Extends Chain Life
- No Wiping (Spray On-Drips Off)



Cat. #	Description	Price
70424022	22oz. Trigger Spray Bottle	\$ 2.10
47504001	Gal. Bottle Chain-Lube	17.83

## VACUUM PUMP OIL

Mobile Vacuum Pump Oil is a special lubricant that is designed to be used for the lubrication of very severe vacuum pumps. It has a very low vapor pressure and can be used when extremely high vacuums are required. It provides excellent wear and corrosion protection for vacuum pump protection.

Cat. #	Description	Price
VPOIL	Qt. Bottle Vacuum Pump Oil	\$ 6.65



# PRESS Jomac, Ryobi, Veratec, Hyton Dampening Covers

## JOMAC A-TEX® COVERS

A seamless water form and ductor cover made of 100% cotton offering high absorbency and long life. These covers are normally used when Molleton brand is no longer available.

Cat. #	Roller Diameter	Style	25 YD Box
DV-L15	Under 3/4"	LL-15	\$126.50
DV-L25	3/4" - 1 1/8"	LL-25	127.50
DV-L50	1 1/4" - 1 1/2"	LL-50	127.50
DV-L75	1 3/4" - 2"	LL-75	132.00
DV-L100	2 1/8" - 2 3/8"	LL-100	142.50
DV-L150	2 1/2" - 2 9/16"	LL-150	152.50
DV-L175	2 5/8" - 2 11/16"	LL-175	152.50
DV-L200	2 3/4" - 3 1/16"	LL-200	170.00
DV-L3	3" - 3 1/2"	3	185.00
DV-L35	3 3/4" - 4"	3.5	195.25
DV-L4	4 1/8" - 4 1/2"	4	210.00
DV-L5	4 3/4" - 5 1/4"	5	217.50
DV-L6	5 1/2" - 6 1/4"	6	255.00

## JOMAC UNI-DAMP® COVERS

A water form and ductor cover that has a sheared cotton surface that creates a velvety smooth lint-less velour finish.

Cat. #	Roller Diameter	Style	25 YD Box
DA-1125	1 1/8" - 1 1/4"	1125	\$200.00
DA-1150	1 3/8" - 1 1/2"	1150	225.00
DA-1175	1 9/16" - 1 3/4"	1175	237.50
DA-1200	1 3/4" - 2"	1200	237.50
DA-1225	2 1/16" - 2 1/4"	1225	252.50
DA-1250	2 3/8" - 2 9/16"	1250	282.50
DA-1275	2 5/8" - 2 3/4"	1275	295.00
DA-1300	2 7/8" - 3 1/16"	1300	307.50
DA-1325	3 1/8" - 3 5/16"	1325	337.50
DA-1350	3 3/8" - 3 9/16"	1350	375.00
DA-1400	3 5/8" - 4"	1400	382.25

## PRE-CUT DAMPENING COVERS

If your needs are for pre-cut A-TEX or Uni-Damp covers to fit Multilith, Davidson, ATF Chief, Gestetner, AB Dick, Diddi-Glasser, Hamada, Itek and Ryobi duplicator presses - these covers feature drawstrings at both ends. For larger presses the covers are sewn and fitted with a drawstring at one end only.

When ordering please specify make and model of press, choice of material, and if you prefer a form, ductor or set.

Contact **PERFECTION** for price and availability.



## ORIGINAL(O.E.M.) RYOBI TIE-ONS For RYOBI 3302, 3200 MCD

New Moll covers out last, out perform all others. Try them once and you will never settle for anything less.

Cat. #	O.E.M. #	Description	Price Each
DH-RL	5322-53-352	Form	\$20.50
DH-RS	5322-53-163	Ductor	20.50

## COVERS NEW MOLLFOR RYOBI 512

Cat. #	O.E.M. #	Description	Price Each
DH-RLF	5522-53-433	Form	\$26.20
DH-RSD	5522-52-343	Ductor	26.20

## VERATEC

### Red-1 Cut Shrink Covers

This unique fiber construction guarantees a controlled uniform fit that firmly locks the cover onto the roller without pinching down the roller ends.

Red-1 shrink material is tightly knit using only through filament synthetic yarns, this insures lint-free performance. The dense surface controls moisture and provides greater control of the ink/water balance.

### Press Make/Model

ATF Chief	15, 115, 215, 17, 117, 217, 1014, 1015
Davidson	241, 251, 301, 400, 500 Series
Ditto	215, 217
Gestetner	211, 212, 213, 311
Hamada	500, 50-Color Head
Itek	115, 117
Multilith	296, 1250 (all), 1260, 1274, 1275, 2560, 2650, 2850, 2875, 4250, 4975
Townsend	T-51 for 1250, etc...

Red-1	Cat. #	Price Each
Form	DH-RF11	\$10.40
Ductor	DH-RD11	7.70

### Press Make/Model

ATF Chief	2115, 2217
Gestetner	313
Itek	975, 985, 3985
Multilith	1330, 1360, 1362, 1650, 1652
Ryobi	3200, 3302
Townsend	T-51 for 1850 etc.
Didde*	Apollo, IBM 9370, Tandemer 8 1/2
Hamada*	500CDA, 600, 50A160 Color Head, Duetto

\*These presses need only ductors

Red-1	Cat. #	Price Each
Form	DH-RF14	\$11.60
Ductor	DH-RD14	8.60

## HYTON CUT COVER

This product is made of elasticized filament rayon yarns that do not require drawstrings or sewing on ends. These covers insure lint free performance and provide a simple, quick and easy cover change that always fits properly - never too tight or too loose.

Type		Cat. #	Price Each
V.I.P. Form	Fits rollers 1 1/8" to 2 1/4" dia. and 10 1/2" to 11 1/4" long	DH-F2	\$ 7.80
D2 Ductor	Fits rollers 7/8" to 1 1/4" dia. and 10 1/4" to 11 1/2" long	DH-D2	5.90
F2018 Form	Fits rollers 1 1/8" to 2 1/4" dia. and 17 1/8" to 2 1/4" long	DH-2018	10.70
D2017 Ductor	Fits rollers 7/8" to 1 1/4" dia. 17 1/8" to 19 1/8" long	DH-2017	9.40
F1300 Form	Fits rollers 1 1/8" to 2 1/4" dia. and 12 1/2" to 13 1/2" long	DH-13F	8.60
D1300 Ductor	Fits rollers 7/8" to 1 1/4" dia. 12 3/4" to 13 3/4" long	DH-13D	7.00



**MASKING SHEETS - BASE LINE**

GOLDON ROD UNLESS SPECIFIED

■ Priced in Package of 100

Cat. #	Press	Size	Price
<b>AB DICK</b>			
MS-A10	350	10 <sup>1</sup> / <sub>16</sub> " x 16"	\$24.93
MS-A15	360	10 <sup>3</sup> / <sub>16</sub> " x 18 <sup>1</sup> / <sub>2</sub> "	33.32
MS-A20	360A	11 <sup>1</sup> / <sub>16</sub> " x 18 <sup>1</sup> / <sub>2</sub> "	33.32
MS-A22	375	13" x 18 <sup>5</sup> / <sub>8</sub> "	41.76
MS-A24	380	20 <sup>5</sup> / <sub>8</sub> " x 15 <sup>5</sup> / <sub>8</sub> "	47.54
MS-A30	385	23" x 19 <sup>1</sup> / <sub>4</sub> "	69.52
MS-A35	9800,9870,9910,9985	13 <sup>3</sup> / <sub>8</sub> " x 19 <sup>5</sup> / <sub>16</sub> "	41.76
<b>AM MULTILITH</b>			
MS-M10	1250PB	10 <sup>1</sup> / <sub>16</sub> " x 15"	24.93
MS-M20	1250	10 <sup>1</sup> / <sub>16</sub> " x 15 <sup>5</sup> / <sub>8</sub> "	24.93
MS-M30	1250W	11 <sup>1</sup> / <sub>16</sub> " x 18 <sup>1</sup> / <sub>16</sub> "	33.32
MS-M40	1218	13" x 19 <sup>1</sup> / <sub>2</sub> "	41.76
MS-M50	1330,1360,1450,1650,1650SE	12 <sup>7</sup> / <sub>8</sub> " x 18 <sup>3</sup> / <sub>16</sub> "	41.76
MS-M60	1850/60/70,1900/60/62,4610/20	18 <sup>3</sup> / <sub>8</sub> " x 15 <sup>1</sup> / <sub>16</sub> "	44.80
<b>ATF</b>			
MS-C10	Chief 15-115	10 <sup>1</sup> / <sub>16</sub> " x 15 <sup>5</sup> / <sub>8</sub> "	24.93
MS-C20	Chief 17-117	11 <sup>1</sup> / <sub>16</sub> " x 18 <sup>1</sup> / <sub>16</sub> "	33.32
MS-C30	Chief 2000	13 <sup>1</sup> / <sub>16</sub> " x 18 <sup>5</sup> / <sub>8</sub> "	41.76
<b>DAVIDSON</b>			
MS-D2	221,241,251,500,501,560	10 <sup>1</sup> / <sub>16</sub> " x 16"	24.93
MS-D4	600,601,650	17 <sup>5</sup> / <sub>8</sub> " x 13 <sup>3</sup> / <sub>4</sub> "	44.80
MS-D6	233,700,701,702	17 <sup>5</sup> / <sub>8</sub> " x 16 <sup>1</sup> / <sub>16</sub> "	44.80
<b>DIDDE GRAPHICS</b>			
MS-A38	Tandemer-8	13 <sup>1</sup> / <sub>2</sub> " x 9 <sup>1</sup> / <sub>16</sub> "	24.93
MS-A40	Apollo 17	13 <sup>1</sup> / <sub>2</sub> " x 18 <sup>1</sup> / <sub>4</sub> "	24.93
<b>HAMADA</b>			
MS-H50	500,550	10 <sup>7</sup> / <sub>8</sub> " x 15 <sup>3</sup> / <sub>16</sub> "	33.32
MS-H60	600,660,665,665CD	11 <sup>3</sup> / <sub>16</sub> " x 18 <sup>5</sup> / <sub>8</sub> "	38.57
MS-H61	601,602,611,612,661	12 <sup>1</sup> / <sub>16</sub> " x 18 <sup>5</sup> / <sub>8</sub> "	41.76
MS-H70	700,770,775,E47S	18 <sup>1</sup> / <sub>2</sub> " x 15 <sup>5</sup> / <sub>8</sub> "	47.54
MS-H80	800,880	20 <sup>5</sup> / <sub>8</sub> " x 16"	47.54
<b>HEIDELBERG</b>			
MS-H46	GTO-46	18" x 15"	44.80
MS-H52	GTO-52	20 <sup>1</sup> / <sub>4</sub> " x 15 <sup>5</sup> / <sub>8</sub> "	47.54
<b>ROYALZENITH</b>			
MS-R10	20A	20 <sup>5</sup> / <sub>8</sub> " x 15 <sup>3</sup> / <sub>4</sub> "	47.54
MS-R16	126, 226	25 <sup>3</sup> / <sub>4</sub> " x 21"	76.01
<b>RYOBI</b>			
MS-R20	2500, 2700	10 <sup>5</sup> / <sub>8</sub> " x 15 <sup>1</sup> / <sub>2</sub> "	33.32
MS-R30	2800	11 <sup>1</sup> / <sub>2</sub> " x 18 <sup>1</sup> / <sub>2</sub> "	38.57
MS-R40	2800 CDXL	11 <sup>3</sup> / <sub>16</sub> " x 19 <sup>5</sup> / <sub>8</sub> "	41.76
MS-R50	3200 PFA	13" x 19 <sup>1</sup> / <sub>2</sub> "	41.76
MS-R60	3200 MCD	13 <sup>3</sup> / <sub>8</sub> " x 19 <sup>1</sup> / <sub>2</sub> "	47.54
MS-R70	3302	13 <sup>3</sup> / <sub>4</sub> " x 19 <sup>1</sup> / <sub>4</sub> "	41.76
MS-R80	480, 500	19 <sup>1</sup> / <sub>8</sub> " x 16"	47.54
MS-R85	512,520,522	20 <sup>3</sup> / <sub>16</sub> " x 15 <sup>5</sup> / <sub>8</sub> "	47.54
<b>TOKO</b>			
MS-T47	4750	13 <sup>3</sup> / <sub>8</sub> " x 20"	41.76

**Base-Line** Pre-ruled masking sheets are printed one-up on oversized stock, then trimmed with precision. So there is no image spread or trimming deviations. When it comes to paper stock, coating quality and sheet to sheet registration, Base-Line masking sheets are consistent from package to package, order to order.

**CLEAN UP SHEETS - BASE LINE**

- Tough bleached Kraft construction
- Excellent solvent-ink absorption
- Wet strength fibers
- Reduced lint-picking
- A non-calendered surface
- Two-side usage
- Fits all duplicator presses

Prices are per package of 100

Cat. #	Press	Size	Style	Price
<b>A.B. DICK</b>				
CL-AB1	350,320	10 <sup>3</sup> / <sub>16</sub> " x 15 <sup>5</sup> / <sub>8</sub> "	Pinbar	\$24.20
CL-AB3	360	11" x 18 <sup>5</sup> / <sub>8</sub> "	Pinbar	30.15
CL-AB4	375	13" x 18 <sup>1</sup> / <sub>4</sub> "	Pinbar	36.30
CL-AB6	380	15 <sup>5</sup> / <sub>8</sub> " x 20 <sup>5</sup> / <sub>8</sub> "	STR Edge	52.40
CL-AB8	382	19 <sup>3</sup> / <sub>8</sub> " x 22 <sup>3</sup> / <sub>4</sub> "	STR Edge	69.40
CL-AB9	9800	13" x 19 <sup>5</sup> / <sub>8</sub> "	Pinbar	36.30
CL-AB98	385,9880	19 <sup>3</sup> / <sub>8</sub> " x 22 <sup>7</sup> / <sub>8</sub> "	STR Edge	69.40
<b>AM MULTILITH</b>				
CL-AM1	1250W,2650,2850	11 <sup>1</sup> / <sub>8</sub> " x 18 <sup>5</sup> / <sub>8</sub> "	Pinbar	30.15
CL-AM2	1218	12 <sup>3</sup> / <sub>4</sub> " x 18 <sup>1</sup> / <sub>2</sub> "	Pinbar	36.30
CL-AM3	1330	12 <sup>7</sup> / <sub>8</sub> " x 15"	Pinbar	36.30
CL-AM4	1360,1450,1650	12 <sup>7</sup> / <sub>8</sub> " x 18 <sup>1</sup> / <sub>16</sub> "	Pinbar	36.60
CL-15	1250, 2550	10 <sup>5</sup> / <sub>8</sub> " x 15 <sup>1</sup> / <sub>2</sub> "	Pinbar	24.20
CL-AM	1850	18 <sup>1</sup> / <sub>8</sub> " x 15 <sup>1</sup> / <sub>16</sub> "	Pinbar	40.45
<b>ATF</b>				
CL-15	15	10 <sup>3</sup> / <sub>16</sub> " x 15 <sup>5</sup> / <sub>8</sub> "	Pinbar	24.20
CL-17	17	11 <sup>1</sup> / <sub>8</sub> " x 18 <sup>5</sup> / <sub>8</sub> "	Pinbar	30.15
CL-17S	2117, 2217	13" x 18 <sup>1</sup> / <sub>16</sub> "	Pinbar	36.30
<b>DAVIDSON</b>				
CL-D2	221,500,501,560	10 <sup>3</sup> / <sub>16</sub> " x 16"	STR Edge	24.20
CL-D6	600,601,660	17 <sup>5</sup> / <sub>8</sub> " x 13 <sup>3</sup> / <sub>4</sub> "	STR Edge	40.45
CL-D7	233,700,701,702	17 <sup>5</sup> / <sub>8</sub> " x 16"	STR Edge	40.45
<b>HAMADA</b>				
CL-H2	500	10 <sup>7</sup> / <sub>8</sub> " x 15 <sup>3</sup> / <sub>4</sub> "	Slotted	30.15
CL-H3	500	11" x 15 <sup>1</sup> / <sub>2</sub> "	Pinbar	30.15
CL-H4	600,660,665	11 <sup>7</sup> / <sub>8</sub> " x 18 <sup>1</sup> / <sub>32</sub> "	Pinbar	36.30
CL-H5	601,602,DUETTO	12 <sup>7</sup> / <sub>8</sub> " x 18 <sup>1</sup> / <sub>16</sub> "	Pinbar	36.30
	611,612,661,662			
CL-H7	700,770,775	15 <sup>1</sup> / <sub>2</sub> " x 18 <sup>1</sup> / <sub>2</sub> "	Pinbar	40.45
CL-H8	800	15 <sup>7</sup> / <sub>8</sub> " x 20 <sup>1</sup> / <sub>2</sub> "	Slotted	52.40
<b>RYOBI</b>				
CL-27	2700	10 <sup>3</sup> / <sub>16</sub> " x 15 <sup>5</sup> / <sub>8</sub> "	Slotted	30.15
CL-28	2800	11 <sup>3</sup> / <sub>8</sub> " x 18 <sup>5</sup> / <sub>8</sub> "	Pinbar	30.15
CL-28X	2800XL	11 <sup>5</sup> / <sub>16</sub> " x 19 <sup>5</sup> / <sub>8</sub> "	Pinbar	36.30
CL-30	3200LC	13" x 19 <sup>5</sup> / <sub>8</sub> "	Pinbar	36.30
CL-32	3200MCD	13 <sup>5</sup> / <sub>8</sub> " x 18 <sup>5</sup> / <sub>8</sub> "	Pinbar	40.45
CL-32X	3200MCDLC	13 <sup>5</sup> / <sub>8</sub> " x 19 <sup>5</sup> / <sub>8</sub> "	Pinbar	40.45
CL-32P	3200PFA	12 <sup>3</sup> / <sub>4</sub> " x 18 <sup>1</sup> / <sub>2</sub> "	STR Edge	31.85
CL-33	3302M	13 <sup>1</sup> / <sub>4</sub> " x 19 <sup>1</sup> / <sub>32</sub> "	STR Edge	52.40
CL-48	480D,500N	19" x 16 <sup>1</sup> / <sub>16</sub> "	Slotted	40.45
<b>TOKO</b>				
CL-T4	4700CD	13 <sup>1</sup> / <sub>32</sub> " x 18 <sup>5</sup> / <sub>8</sub> "	Pinbar	41.90
CL-T5	4750	13" x 19 <sup>5</sup> / <sub>8</sub> "	Pinbar	36.30

**CHROME CYLINDER CLEANER**

The best we've found, use to deep clean chrome cylinders & dampener rollers. Hint on chrome cylinder use this then apply Blue Etch #A-TF-P(Ref. page 31) to "pickle" cylinder and it will not accept ink.

Cat. #	Description	Price
CY-AB	1/Pt. Bottle Cylinder Cleaner	\$12.70



# PRESS Replacement Parts, Suckers, Flat Suction Discs

- 

**1-KLUGE**, paper suckers. Red or gum rubber.  
**#1 (Rubber)**..... \$4.20/doz.

---

- 

**1p PLASTIC SUCKER**  
 Longer Life  
**#1p** ..... \$4.60/doz.

---

- 

**1a-KLUGE**, narrow margin sucker, very handy in tight places. Red or gum rubber.  
**#1a (Rubber)**..... \$7.20/doz.

---

- 

**2-KLUGE**, card suckers. Red or gum rubber.  
**#2 (Rubber)**..... \$4.20/doz.

---

- 

**3-KLUGE**, carton suckers. Red or gum rubber.  
**#3 (Rubber)**..... \$7.20/doz.

---

- 

**4-UNIVERSALTIPS**, light duty C & P, Giant, Web, Chief.  
**#4 (Rubber)**..... \$7.20/doz.

---

- 

**5-UNIVERSALTIPS**, heavy duty C & P, Giant, Web, Chief.  
**#5 (Rubber)**..... \$7.20/doz.

---

- 

**6a-MACEYCOLLATOR**, cardboard Harris pickup sucker for cardboard.  
**#6a** ..... \$7.20/doz.

---

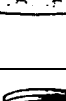
- 

**7-HARRIS** old style Giant, Web, chief, Harris for cardboard. Gum rubber or black.  
**#7 (Gum Rubber)**..... \$7.20/doz.  
**#7 (Black)**..... \$8.40/doz.

---

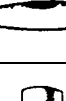
- 

**8-HARRIS** old style Giant, Web, Chief, Harris, C & P, for paper.  
**#8** ..... \$7.20/doz.

---

- 

**9-MILLER** Simplex, Major. Southworth envelope press suction feed. Fits 1/4" tube. For paper.  
**#9** ..... \$7.20/doz.

---

- 

**10-MILLER** Simplex, Major for cardboard. Gum rubber or black.  
**#10 (Gum Rubber)**..... \$7.20/doz.  
**#10 (Black)**..... \$7.20/doz.

---

- 

**11-HARRIS 90 ELB**, fits most presses. Mann, Macey Collator and Stitcher. 6E7-paper. 6E8-cardboard. HTB Miehle feeders.  
**#11 (6E7)**..... \$7.20/doz.  
**#11 (6E8)**..... \$7.20/doz.

---

- 

**12-HARRIS, 1361 LTN** fits most presses, for paper. Gum rubber or silicone.  
**#12a Gum Rubber** ..... \$7.20/doz.  
**#12b Silicone** ..... 15.00/doz.

- 

**13a-MIEHLE CS3122 FEEDER**, Super-Chief light forwarder, Miller, Didde Glaser Collator, for paper.  
**13b-MIEHLE CS3124 FEEDER**, Super-Chief heavy forwarder, Dexter, Giant, for cardboard. Both fit Ebco presses.  
**#13a** ..... \$17.40/doz.  
**#13b** ..... \$17.40/doz.

- 

**14-MIEHLE CS427 FEEDER**, Farrington Collator, Giant, Web, Chief, for paper.  
**#14** ..... \$7.20/doz.

- 

**15-MIEHLE CS1026 FEEDER**, Giant, Web, Chief, for cardboard.  
**#15** ..... \$7.20/doz.

- 

**15a-MACEYCOLLATOR**, Harris pickup sucker for paper.  
**#15a** ..... \$7.20/doz.

- 

**16-C&P, RICE**, Kluge "D" delivery, for paper and light cardboard.  
**#16** ..... \$7.20/doz.

- 

**17-KLUGE**, for narrow margin work. Use on feeder or delivery.  
**#17** ..... \$9.00/pr.

- 

**18-KLUGE**, Same as #17 Rubber disc 19K added for cardboard.  
**#18** ..... \$9.00/pr.

- 

**19-FLAT RUBBER SUCTION DISCS** Kluge (K), Heidelberg (H), Hawes (Ha), others (send sample).  
**#19 H**..... \$1.60/doz.  
**#19 AB Dick 1/2"**.....\$1.20/doz. **#19 Ha**..... \$1.60/doz.  
**#19 AB Dick 3/4"**.....\$1.60/doz. **#19 W**..... \$1.60/doz.  
**#19 K**.....\$1.60/doz. **#19 RZ** ..... \$1.90/doz.

For special sizes when ordering, specify width, diameter of hole, and thickness of disc.

**CROSS REFERENCE SHEET**  
**No. 19 - FLAT RUBBER SUCTION DISCS**

Stock Sizes	O.D. x I.D.	Stock Sizes	O.D. x I.D.
5/8" x 1/8"	1 1/4" x 3/8"	1 1/16" x 1/4"	1 5/8" x 3/8"
3/4" x 3/16"	1 1/4" x 1/2"	1 1/16" x 3/8"	1 5/8" x 1/2"
3/4" x 1/4"	1 1/4" x 9/16"	1 1/8" x 1/4"	1 5/8" x 9/16"
7/8" x 3/16"	1 1/4" x 3/8"	1 1/8" x 1/2"	1 5/8" x 5/8"
7/8" x 1/4"	1 1/4" x 1/2"	1 1/8" x 9/16"	1 3/4" x 5/16"
1" x 3/16"	1 1/4" x 9/16"	1 3/16" x 3/8"	1 3/4" x 1/2"
1" x 1/4"	1 1/2" x 3/8"	1 3/16" x 1/2"	1 3/4" x 9/16"
1" x 3/8"	1 1/2" x 1/2"	1 3/16" x 9/16"	1 3/4" x 5/8"
1 1/16" x 1/8"	1 1/2" x 9/16"	1 1/4" x 3/16"	2" x 1/2"

**Thickness Guide**

- White ..... 1/2 mm (.015)
- Pink..... 1/32 mm (.032)
- Tan..... 1 mm (.040)
- Beige..... 1/16 mm (.062)
- Green..... 2 mm (.080)

- #19 Spec.** Rubber to 1 1/2" ..... \$0.30/ea.
- #19 Spec.** Rubber over 1 1/2" ..... 0.40/ea.
- #19 Spec.** Poly to 1 1/2" ..... 0.35/ea.
- #19 Spec.** Poly over 1 1/2" ..... 0.45/ea.





# PRESS Replacement Parts, Suckers, Sheet Tongues, Belts, Wrenches

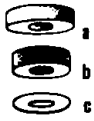

- 20-WASHERS**, Miehle vertical.
- #20a feedboard ..... \$3.00/doz.
  - #20b gripper bar..... 3.00/doz.
  - #20c gripper head (thin) ..... 3.00/doz.



- 21-SANDPAPER DISCS**, Kluge, C&P, others. Standard 3/4" or extra large 1 1/8".
- #21a ready glued..... 3.00/doz.
  - #21a ready glued x-large ..... 3.60/doz.
  - #21b without glued ..... 2.10/doz.
  - #21b without glue x-large ..... 2.40/doz.



- 22-HEIDELBERG SUCKER KLUGE**, new style. Delivery gripper will not tear this.
- #22 ..... \$6.00/doz.

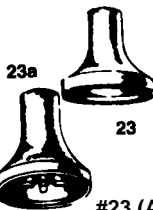

- 23-RUBBER SUCTION TIP**, 5/8" across – fits inserting and gathering machines. Sheridan, McCain, Phillipsburg. Various compounds available. Submit sample.
- #23 (Amber) ...\$13.00/100 #23V (Black) ...\$13.00/100  
 #23V (Tan) ..... 13.00/100 #23S ..... 18.00/100  
 #23V (Blue) .... 13.00/100 #23 (Yellow)..... 18.00/100  
 #23V (Red) ..... 13.00/100 #23A ..... 4.80/doz.  
 #23 (Large) ..... 4.80/doz.



- 26-KLUGE METALCAP**  
 Holds standard rubber sucker. For feeder and delivery.
- #26 ..... \$ .90/ea.



- 27a- BRASS SUCKER**, for Chief and Webendorfer Offset Presses, for paper.
- #27a ..... \$9.50/ea.
- 27b- BRASS SUCKER**, for Chief and Webendorfer Offset Presses, for cardboard. Add a #4,7,8,14, or 15 rubber sucker.
- #27b ..... \$6.25/ea.



- 28-MIEHLE FEEDER CAP**, shuts off openings on feeder bar.
- #28 ..... 1.60/doz.

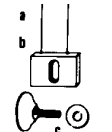

- 29-MIEHLE VERTICAL**, fluffer wires.
- #29a for Paper ..... \$15.00/doz.
  - #29b for Cardboard ..... 16.00/doz.
  - #29c Thumb Screw w/Washer..... .45/ea.



- 30a-MIEHLE VERTICAL**, air release valve. Used on feeder arm instead of #28 cap. Release a little air by turning screw. Excellent for cardboard and tissue.
- 30b-MIEHLE VERTICAL**, cylinder gripper, Complete only. Fits all verticals.
- #30a ..... \$9.00/ea.
  - #30b ..... 12.00/ea.

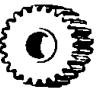

- 31a-FIBER GEAR**, fits all Miehle verticals.
- #31a ..... \$30.00/ea.

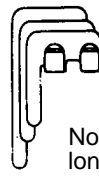

- 32-Job Press Gripper Fingers**, fits Kluges, C&P, etc. Short, long, extra long. Standard and narrow widths.
- #32 Standard ..... \$19.80 set of 6
  - #32 Narrow ..... 19.80 set of 6
- Note, sets contain 2 each short, long and extra long. You may order any length in sets of six.

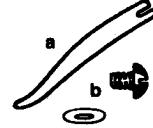

- 33a – KLUGE SHEET TONGUES**  
 Sizes 1 to 6.
- 33b – SHEET TONGUE SCREW**. Fits all Kluges. Includes washer.
- #33a ..... \$16.50 1/2 doz.
  - #33b ..... .75/pkg of 3



- 34 – MIEHLE VERTICAL TRANSFER TABLE LEVER KEY**. Keeps feedboard in place. Fits all models.
- #34 ..... \$18.00/ea.



- 35 – MIEHLE VERTICAL BACKSTOPS**. Fits all plain boards. Simple instructions.
- #35 ..... \$12.00/pr.



- 36 – KLUGE REGISTER ROD CAM**. Left or right.
- #36 ..... \$26.00/ea.



- 38a – ENDLESS BELTS**, Vertical, Giant, Kluge, others. Leather, fabric and elastic for delivery, drive and conveyor.
- #38a – Belts, V-36, V-45, V-50 Pre War**
- Leather Drive..... \$ 95.00/ea.
  - Leather Motor..... 72.00/ea.
  - V-50 Post War Leather Drive..... 106.00/ea.
  - Kluge..... 115.00/ea.

- SMALL OFFSET PRESSES**
- R-120-6050 Fabric..... 12.00/ea.
  - R-2164-U-53..... 13.00/ea.



- 41-VERTICAL PIN WRENCHES**
- a – Straight type, small and large
  - b – "S" type, small.
- #41a ..... \$ 3.50/ea.
  - #41b ..... 3.50/ea.
  - #41a Large ..... 12.00/ea.



- 43-KLUGE REGISTER ROD HOLDER**
- #43 ..... 13.50/ea.

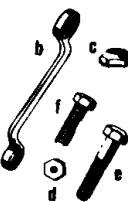

- 44-KLUGE WRENCH SET**  
 Includes all popular nuts and bolts.
- #44a Complete 7-Piece Set ....\$ 14.00/set
  - #44b Wrench ..... 9.50/ea.
  - #44c Gripper Nut..... .45/ea.
  - #44d Side Guide Nut ..... 1.50/ea.
  - #44e Delivery Pickup Bolt ..... 1.75/pr.
  - #44f Delivery Track Bolt ..... 1.60/ea.

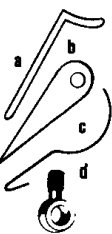

- 45-KLUGE MISCELLANEOUS PARTS**  
 Fits all models.
- #45a Side Guide Tongue ..... \$ 4.00/doz
  - #45b Magazine Separator Spring ..... 1.50/pr.
  - #45c Center Comber Spring... .75/ea.
  - #45d Side Guide Eye Bolt ..... 6.00/ea.  
 (holds side guide to platen)



# PRESS Replacement Parts, Suckers, Book Clamps, Side Guides, Fasteners



**46-BOOK TRIMMING GUIDES.** Challenge style, bolt portion fits on back finger gauge of cutter. Keeps any size booklets flat for trimming.  
**#46** ..... \$33.00 pair

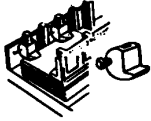

**BN-22-BOOK TRIMMING GUIDES.** Economy style, fits on back gauge of cutter.  
**#BN-22** ..... \$24.00 pair

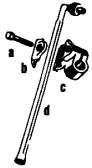

**48-KLUGE**  
**#45a Delivery Pickup Bolt** ..... \$ 4.00/dz.  
**#45b Delivery Pickup Clamp Top** ..... .75/ea.  
**#45c Delivery Pickup Clamp Base** ..... .75/ea.  
 (specify left or right)  
**#45d Delivery Pickup Suction Tube** . . . 6.00/ea.

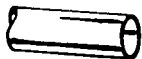

**50-PLASTIC HOSE AND TUBING**  
 For Verticals, Kluges, Offset.  
 Rubber tubing available for Miehle Vertical.

**#50 Gum Tubing**  
 3/16" Diameter.....\$1.70 ft.  
 1/4" Diameter ..... 1.80 ft.  
 3/8" Diameter..... 1.95 ft.

**#50 Plastic Tubing**  
 3/16" Diameter.....\$ .60 ft.  
 1/4" Diameter..... .60 ft.  
 5/16" Diameter..... .65 ft.  
 3/8" Diameter..... .70 ft.  
 1/2" Diameter..... .85 ft.  
 5/8" Diameter..... 1.10 ft.  
 3/4" Diameter..... 1.35 ft.

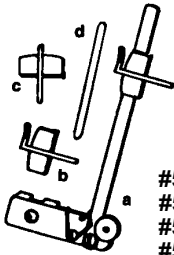

**51a** – Kluge Side Guide, complete, left or right.  
**51b** – Kluge Side Guide Block.  
**51c** – Bottom Feed Gauge.  
**51d** – Feed Gauge Tongues only.

**#51a** .....\$ 41.00/ea.  
**#51a Long**..... 43.00/ea.  
**#51b** ..... 16.50/ea.  
**#51c** ..... 16.50/ea.  
**#51d** ..... 4.00/doz

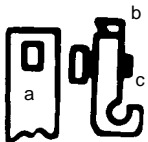

**52-KLUGE**  
**a** – Kluge bottom gauge band. Specify length 19 1/2", 23 1/4", or 25 1/2".  
**b** – Kluge Bottom Gauge Band Clamp. Quick release.  
**c** – Kluge Bottom Gauge Band Clamp with screw to hold band. Specify left or right.

**#52a** .....\$9.00/ea.  
**#52b** ..... 15.00  
**#52c** ..... 15.00



**53-BLOWER FLEXIBLE STEEL TUBING**  
 Fits all Kluges. 5'length.  
**#53** ..... 25.50

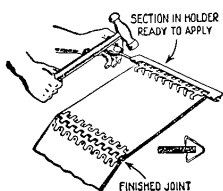

**ALLIGATOR FASTENERS**  
 WILL JOIN ENDS OF TAPE  
 UP TO 2" WIDE

**#A-L-00** ALLIGATORPRESS TAPE FASTENERS .....\$17.20/Box

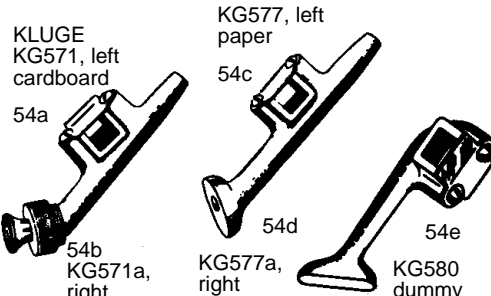

**KLUGE**  
 KG571, left cardboard  
 54a  
 KG577, left paper  
 54c  
 KG571a, right  
 54b  
 KG577a, right  
 54d  
 KG580 dummy  
 54e

**#54 a**.....\$22.50/ea. **#54d**..... \$22.50/ea.  
**#54b** ..... 22.50/ea. **#54e**..... 13.00/ea.  
**#54c** ..... 22.50/ea.

**55-MF MIELE FEEDER.**  
 Pickup rubbers for MF Miehle feeders and ATF Super Chief.  
**#55** ..... \$24.00/doz.

**56-MF MIEHLE FEEDERS.** MF 3336 and packaging machines. Fits 1/2" tube. For light stock. Gum rubber or Neo.  
**#56 (Rubber)** ..... \$15.00/doz.  
**#56 (Neoprene)** ..... 17.40/doz.

**57-HARRIS 1108**, for heavy stock. Fits 5/8" tube.  
**#57** ..... \$15.00/doz.

**58-CS-11398** Miehle Stream feeders, packaging machines. Fits 1/2" tube-1-3/8" across. Occasionally replaces 3122, 3123, 3124.  
**#58 (Gum Rubber)** ..... \$15.00/doz.  
**#58 (Poly)** ..... 21.00/doz.

**59-HARRIS 956 ELB**, for light stock. Fits 5/8" tube. 1 3/8" across.  
**#59** .....\$16.20/doz.

**60-MIEHLE FEEDERS** – MF 3558 packaging machines. Super Chief Tissue Sucker fits 1/2" tubes 1" across. For light stock. Gum rubber or Neo.  
**#60 (Gum Rubber)** ..... \$16.20/doz.  
**#60** ..... 17.40/doz.

**61-HARRIS 391 ELB** for heavy stock. Fits 5/8" tubes. 1 3/8" across.  
**#61** ..... \$12.00/doz.

**62-CS-357** for CS Miehle feeders. 1 1/4" across.  
**#62** ..... \$12.00/doz.

**63-SHERIDAN**, and other collators with 1/8" tube.  
**#63** ..... \$6.60/doz.

**64-MIEHLE FEEDERS, K-1196.**  
**#64** ..... \$6.00/doz.



# PRESS Replacement Parts for Kluge, Miehle, C & P, Xacto Knife, etc.

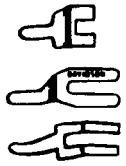

**65-SHEET SEPARATORS** (Cat whiskers)  
For small offset presses. Specify press.  
Multilith, Hamada, Davidson, Chief, Ryobi-  
Itek, Komori, or Fuji.

**Multilith, Hamada, Davidson**

- #65 Brass .....\$4.25/doz.
- #65 Bronze .....5.00/doz.
- #65 Chief .....5.00/doz.
- #65 Ryobi .....8.00/doz.
- #65 Komori or Fuji .....9.00/doz.



**66-A.B. DICK** molded sucker. For all presses  
with 1/4" bottom tube.

- #66 ..... \$3.00/doz.



**67-HARRIS** polyurethane for heavy stock. Fits  
5/16" tube. Occasionally replaces 59 and 61. 1 3/4"  
across. Equivalent to 3361-LTY.

- #67 ..... \$21.60/doz.



**68-HEIDELBERG** cylinders. Cup shape  
prevents snap-back.

- #68 ..... \$6.00/doz.



**69-GRIPPER BOLTS**, for C&P, Kluge, or  
Kluge D. Specify press. Sold in pairs.

- #69 ..... \$3.75/pr.



**70-RYOBI/ITEK**, telescoping sucker. Comes  
with #19R Discs.

- #70 ..... \$14.00/ea.

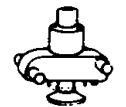

**71-MIEHLE VERTICAL**, telescoping sucker for  
cardboard & envelopes. Fits existing shoe.  
Comes with #30A vacuum valve and #19K discs.

- #71 ..... \$35.00/pr.

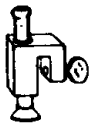

**72-MIEHLE VERTICAL**, telescoping sucker.  
Comes with #19K discs. For difficult and wavy stock.

- #72 ..... \$35.00/pr.

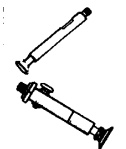

**73-A.B. DICK**, telescoping sucker. Comes with  
#19K discs. For difficult and wavy stock.

- #73 ..... \$12.00/ea.



**73p-A.B. DICK**, plastic telescoping sucker with  
shut-off valve. Comes with a #66 sucker.

- #73p ..... \$5.50/ea.



**74-A & B SET- MULTILITH or HAMADA**,  
telescoping suckers. Uses #19K discs. For difficult  
and wavy stock.

- #74 ..... \$45.00/set.



**74-C NEW STYLE MULTILITH**, telescoping  
sucker. 1250-1250W and 1850. Comes with #19K  
discs.

- #74c ..... \$14.00/ea.

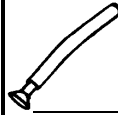

**75-CHIEF 15 & 17** telescoping sucker. Uses 19K  
or 19-AB Dick Discs. For difficult and wavy stock.

- #75 ..... \$28.00/pr



**76-Mueller** sucker for collating and gathering  
machines (a) Red (b) Black.

- #76a Red ..... \$3.85/doz.
- #76b Black ..... 3.85/doz.



**77-Mueller** green sucker for collating and  
gathering machines.

- #77 ..... \$3.60/doz.



**78-HAMADASTAR**,sucker for printing press.

- #78 ..... \$9.00/doz.



**79-ASTRO and SANDMAR** envelope and sheet  
feeders. Specify medium or heavy.

- #79 Medium ..... \$7.80/doz.
- #79 Heavy ..... 7.80/doz.



**80-ATF-Commander 29** Speiss feeders,  
Heidelberg. For thin stock.

- #80 ..... \$21.00/doz.



**81-KLOCKNER 18092-1** packaging machines.  
1 1/8" across, 1/2" high. Black, Red or Blue or Tan.

- #81 All Colors ..... \$18.00/doz.



**82-RYOBI**, Ryobi-Itek.

- #82 ..... \$6.00/doz.



**83-Heidelberg GTO** offset presses.

- #83 ..... \$4.20/doz.



**85-PLASTIC SUCKER**, without hook for toys or to  
hand window display.

- #85 ..... \$2.00/doz.



**86-KLOCKNER 18092**, packaging machines.  
1 1/2" across, 3/4" high. Black, Red, Blue, or Tan.

- #86 ..... \$21.00/doz.



**88-HAMADACK 02-77**, printing presses.

- #88 ..... \$12.00/doz.











## NO. 1 XACTO KNIFE



- X3001-No. 1-Xacto Knife.....\$ 3.65
- X11-Package of five blades ..... 2.55
- X811-Package of 100 blades..... 32.45



# PRESS Replacement Parts, Suckers,

	<b>89-HARRIS 398-0026</b> , 7/8" across bottom. #89 ..... \$4.20/doz.		<b>102-HORIZON COLLATOR 3013</b> , small dark grey sucker. #102 ..... \$20.00/doz.
	<b>90-TOKO DYY-9-R1, MULTI 1218-CJ-11, IMPERIALCJ-11</b> , Bourg Modulen Colator. #90 ..... \$24.00/doz.		<b>103-HORIZON COLLATOR 3015</b> , large blue sucker. #103 ..... \$18.00/doz.
	<b>91-HAMADAH05-49-01-3</b> , black plastic tube. #91 ..... \$14.40/doz.		<b>104-DUPLO COLLATOR</b> , bellows type sucker. #104 ..... \$22.00/doz.
	<b>92-Heidelberg 22.016.008</b> For T- press TOK-TOM. #92 ..... \$7.20/doz.		<b>RVC 147B BOURG MODULEN COLLATOR</b> , Vinyl. #RVC 147B up to 41 doz. .... \$36.00/doz. #RVC 147B over 42 doz. .... \$26.00/doz.
	<b>93-MULLER 020.1913</b> , collating and gathering machines. #93 ..... \$11.00/doz.		<b>RVC 176 A.B. DICK CENTURY 3000</b> , Bellows type sucker. #RVC 176 ..... \$48.00/doz.
	<b>94-PHILLIPSBURG</b> , inserts, bellow type. #94 ..... \$11.00/doz.		<b>CHIEF 24 LIGHT</b> , for light stock. Chief 24 Light ..... \$18.00/doz.
	<b>95-McCAIN</b> , bellow type. #95 ..... \$11.00/doz.		<b>CHIEF 24 HEAVY</b> , for heavy stock. Chief 24 Heavy ..... \$18.00/doz.
	<b>96-HARRIS/AURELIA</b> , bellows type. 1 1/4" across 1" high. #96 ..... \$42.00/doz.		<b>CUMMINGTON COLLATOR, MIEHLE</b> Vertical for cardboard. Cummington ..... \$18.00/doz.
	<b>97-RYOBI, 5640-35-531</b> . #97 ..... \$30.00/doz.		<b>RCS 3121 MIEHLE CS FEEDERS</b> , For heavy stock or sheet metal 1 7/8" high, 1 1/16" across. Fits 3/4" OD tube or 1/2" pipe. RCS 3121 ..... \$21.00/ea.
	<b>98-MULLER 020.1901</b> , Orange rubber cap #98 ..... \$5.50/doz.		<b>RCS 3123 MIEHLE CS and other FEEDERS</b> , For cardboard 1" high, 1 1/4" across. Fits 1/2" OD tube. RCS 3123 ..... \$18.00/ea.
	<b>99-Heidelberg 42.016.073</b> , for GTO. #99 ..... \$18.00/doz.		<b>RTF 1999 MIEHLE TF and other FEEDERS</b> , For cardboard or sheet metal 1 7/16" high, 1 1/16" across. Fits 3/4" OD tube or 1/2" pipe. RTF 1999 ..... \$18.00/ea.
	<b>100-NORFIN COLLATOR</b> #100 ..... \$19.00/doz.		
	<b>101-UHLMANN PACKAGING MACHINES</b> #101 ..... \$14.00/doz.		





**RTF 1648 MIEHLE TF and other FEEDERS**, for heavy cardboard or sheet metal 2 1/8" high, 2 1/2" across. Fits 3/4" OD tube or 1/2" pipe. Gum rubber or Neo.

- RTF 1648 Gum rubber..... \$25.00/doz.
- RTF 1648 Neoprene..... \$31.00/doz.



**TELESCOPING SUCKER**, for ATF Chiefs except Super Chief & Chief 15. Used with flat disc 19W.

- Part E..... \$10.00/ea.



**FEED SUCKER BLOCK**, for Chief 20,22,29 Presses. Convenient thumb screw for adjustment. Holds part E.

- Part F..... \$10.00/ea.



**301-PAPER STOP DEFLECTOR**, clear rigid plastic. Equivalent to Chief M-1-184.

- #301..... \$14.00/ea.



**302-WRENCH**, open end. Equivalent to Chief special wrench. W2155 x 22.

- #302..... \$7.00/ea.



**303-CHIEF 15-17 GRIPPER**, light and flexible.

- #303..... \$5.45/ea.



**DRILL ADAPTOR** – If you want to drill paper with a standard wood or metal drill – use this Drill Adaptor and Style D Hollow Drills.

- Adaptor..... \$30.00/ea.

**HS BOYD PRODUCT INFORMATION**

**Standard Score**

HS BOYD #827 Scoring blades for paper and light-weight card stock have a blade height of .0155 inch and are effective for: index weight card stock, all paper-weighted stock and all light-weight card stock up to 2-ply index weights.

Card stock #827-3 scoring blades with a blade height of .024 inch are suggested for: all coated stock up to 10 to 12 points, enamel stocks, cast coated paper and 80 pound cover stocks.

(These scoring blades are specifically designed to decrease the likelihood and amount of cracking associated with scoring on most coated and heavy enamel stocks.)

**Special low & High Scoring**

HS BOYD scoring blades are available from .0125 inch to as high as .029. Generally, the lower blade heights work well on light-weight stocks – with the higher blades effective for: coated paper above 12-point, heavier enamel or cast coated stock & heavier cover stocks.



**HS BOYD LITHO-PERF On Press**

- PERFORATING
- SCORING
- SLITTING
- PUNCHING

Litho-Perf rule is a thin flexible steel band which has precision made cutting teeth along one edge. It is designed to be applied to the impression cylinder of an offset press. Packed in convenient dispenser box with full instructions and tape which requires only a few minutes to set up.

**LITHO-PERF/SIDE-SERIES**

Perforating product that offers high quality performance. Special blade heights are available on request.

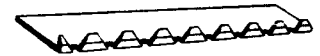

LITHO PERF					
Cat. #	Length	Teeth	Stock	Height	Price
LP-810	20'	8	Paper	.019	\$39.50
LP-811	20'	8	Card	.024	39.50
LP-812	20'	12	Paper	.019	39.50
LP-813	20'	12	Card	.024	39.50
LP-814	20'	16	Paper	.017	39.50
LP-815	20'	16	Card	.024	39.50

**LITHO SCORE**

This rule prepares stock for a neater fold. Special heights are available.



LITHO SCORE					
Cat. #	Length	Teeth	Stock	Height	Price
LS-827	20'	N/A	Both	.015	\$39.50

**LITHO SNAP**

Perforation that will snap apart easily even when in large sets.

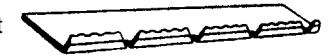

LITHO SNAP					
Cat. #	Length	Teeth	Stock	Height	Price
LS-821	20'	3	Paper	.021	\$39.50
LS-824	20'	4	Paper	.021	39.50
LS-825	20'	4	Card	.025	39.50

**LITHO SLIT**

Designed for slitting, die cutting, windows, corner cut outs or insertion slots.

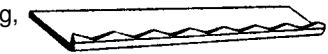

LITHO SLIT					
Cat. #	Length	Teeth	Stock	Height	Price
LS-830	20'	N/A	Paper	.024	\$39.50
LS-831	20'	N/A	Card	.026	39.50

**MICRO PERF**

Designed for perforating continuous feed forms. The perf remains clean with no rough edges.

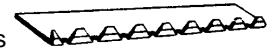

MICRO PERF					
Cat. #	Length	Teeth	Stock	Height	Price
LP-301	20'	30	Paper	.022	\$47.50
LP-401	20'	40	Paper	.022	63.25
LP-501	20'	50	Paper	.022	80.00

**Note:** Many other special products such as Litho-Punch, Litho-Dies, Door knob dies, etc...not listed here are available through Perfection. Please call for free catalog of complete listings.



# CHEMICALS Aerosol Cans, Cleaners, Preservers, Lubricants, Safety Cans



## **A** GUM ARABIC 14° BE

100% pure, finest quality gum arabic available.

Cat. #	Unit	Price
A-NG-2438	Qt.	\$ 8.90
	12+	8.28

## **B** BRITE POLISH

Polishes, shines and protects metal surfaces. Dries fast without wax build-up.

Cat. #	Unit	Price
BR-806	11 oz.	\$17.20
	12+	15.05

## **C** GLASS CLEANER

For chrome and glass, leaves no film.

Cat. #	Unit	Price
GN-40	15 oz.	\$ 3.15
	12+	2.60

## **D** INK PRESERVER

Stops ink skinning, eliminates washups.

Cat. #	Unit	Price
INK PR	12 oz.	\$ 5.60
	12+	4.80



## CAMERA & PRESS PRODUCTS

### ELECTROSTATIC TONER

■ A premixed liquid toner of a density highly suitable for the Itek® and Iwatsu® families of platemakers.

Cat. #	Description	Gallon	Price
ES-W2	W-Toner	Quart	\$ 12.80
		6+	12.03

### ELECTROSTATIC DISPERSANT

■ For use in adjustment of toner intensity in wet toner systems. Has the lowest evaporation point of all domestic dispersants.

Cat. #	Description	Gallon	Price
ES-D2	Dispersant	Quart	\$ 4.20
		6+	3.96



## **E** ROLLER CLEANER

Cleans and rejuvenates hardened rubber rollers.

Cat. #	Unit	Price
R-200	13 oz.	\$12.50
	12+	11.04

## **F** SPRAY ADHESIVE

For lay-outs, display assembly, labeling, etc. Creates temporary or permanent bond.

Cat. #	Unit	Price
SP-166	16 oz.	\$5.50
	12+	4.70

## **G** ANTI STATIC SPRAY

Eliminates static any place it may generate.

Cat. #	Unit	Price
ST-X2	14 oz.	\$ 5.05
	12+	4.15

## **H** SILICONE SPRAY

Reduces friction, stops sticking and binding.

Cat. #	Unit	Price
SL-946	11 oz.	\$ 4.15
	12+	3.40

Lubricates, prevents Rust and corrosion on metal surfaces, dries fast with no oily film.

Cat. #	Unit	Price
SL-945	11 oz.	\$ 4.60
	12+	3.90



### SELF-CLOSING DISPENSING CANS

■ Dispenses small amounts right on the work. Spill-proof, opens by finger pressure, closes automatically. Red non-metallic brass nozzle.

Capacity	Cat. #	Price
1-Quart	JB-14010	\$30.60





**SAFETY CANS**

- For safe handling and storage of flammable liquids
- For positive fire prevention at lower insurance rates
- Approved, individually labeled and numbered by Underwriter Laboratory.

Capacity	Cat. #	Price
1-Quart	JS-10101	\$36.65
½-Gallon	JS-10201	26.80
1-Gallon	JS-10301	30.00
2-Gallon	JS-10501	31.95
5-Gallon	JS-10801	35.00

Fire-tested high density polyethylene safety cans. FM approved, UL listed, 2-qt. thru 5-gal. capacities.



**PLUNGER CANS**

- The best way to handle flammable liquids used in "sponging" and cleaning operations. Pushing down on pan pumps liquid into pan to moisten sponge or rag. Surplus liquid immediately drains back into can.

Capacity	Cat. #	Price
1-Pint	JP-10008	\$35.40
1-Quart	JP-10108	37.90
½-Gallon	JP-10208	39.00

Approved plunger and bench cans, wash and dip tanks. Off-the-shelf in any sizes you need. Send for bulletin.



**OILY WASTE CANS**

- Approved and individually labeled and numbered. Underwriters laboratory, Inc. Essential wherever waste, solvent cloths and wiping rags are used. Protects flammable materials from fire-making sparks. Smoker carelessness, and from spontaneous combustion. Foot lever lifts cover.

Capacity	Cat. #	Price
6-Gallon	JO-9100	\$ 47.20
10-Gallon	JO-9300	54.20
14-Gallon	JO-9500	62.30
21-Gallon	JO-9700	102.70



RYOBI MODEL 3302 — ITEK MODEL 3985 — A.B. DICK 9985

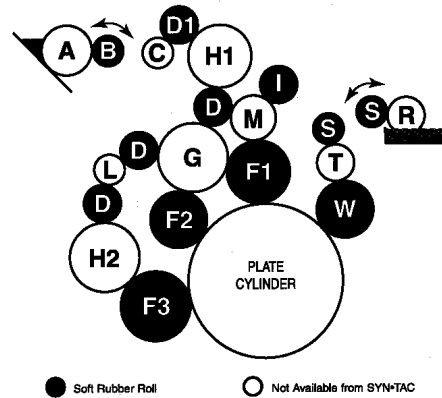

**EACH ROLL IS DESIGNED AND MANUFACTURED TO DO A SPECIFIC JOB.**

Just as rolls differ in size, they also differ in rubber formula, hardness and face-to-core thickness.

**SYN-TAC** rolls are individually designed and manufactured to perform the way the press manufacturer intended.

**THE QUALITY IS BUILT-IN!**

Only the finest rubber formula is compounded for every **SYN-TAC** roll. Bonded to a new steel core or shaft, it is ground to precise tolerances with a velvet finish to ensure proper transfer of the ink film.

FOR YOUR CONVENIENCE WE STOCK ROLLERS FOR MOST OF THESE POPULAR OFFSET PRESSES, AND ARE READY FOR IMMEDIATE SHIPMENT.

- Multilith** . . . . 1250, 1250LW, 1218, 1330, 1360, 1650, 1650XE, 1850, 1860, 1860GPC, 1870, 1870N, 1960MC, 1960XE, 1962
- Toko** . . . . . 1800, 4700, 4750CD, R2
- A.B. Dick** . . . . 350, 360, 360PRO, 375, 375PRO, 9800 series, 380, 382, 385, 385PRO, 9880, 9890
- Ryobi** . . . . . 2700, 2800, 3200, 3200MCD, 3200PFA, 3302, 500-N, 510 series, 520 series
- Itek** . . . . . 950, 960, 975, 975PFA, 985, 3985
- Townsend** . . . . T51 for Toko, Multilith, AB Dick, Chief, Ryobi, Itek
- Hamada** . . . . 500, 500CDA, 600, 600CD, 611 series, 612 series, C-248, C-252, RS34, VS34, 700 series, 800 series
- ATF Chief** . . . . 15, 115, 215, 17, 117, 217, Super Chief, 2217XL
- Davidson** . . . . 221, 233, 241, 242, 251, 400, 500, 501, 502, 600, 601, 700, 701, 702
- Didde** . . . . . Tandemer 8fi, 1713-A, 1713-B, OP1713A, OP1713B, 175
- Heidelberg** . . GTO 46, GTO 52, numbering rollers for both





## ONE-PART FOUNTAIN SOLUTIONS

### EMERALD® PREMIUM MX SERIES

This line of one-step fountain solutions has truly become the standard of the industry!

- Fast start-ups
- Reduced ink feedback
- Wide latitude
- Excellent print reproduction
- Sharp half-tones

### EMERALD® PREMIUM MX3Z

Specially formulated to run on high-speed web presses with aqueous or solvent plates. No blinding problems here. Effective on both continuous and brush presses. Also contains a strong buffering system, phosphate-free.

Cat. #	Description	Unit	Price
A-NE-2837	Emerald premium MX3Z	Gal. 4+	\$28.20 26.23

### EMERALD® PREMIUM MXEH

Effectively reduces feedback on even the toughest continuous damping systems on high-speed web presses.

Cat. #	Description	Unit	Price
A-NE-2912	Emerald premium MXEH	Gal. 4+	\$28.20 26.23

### EMERALD® PREMIUM WCMX

Designed for use in the soft and medium water conditions on brush and continuous dampening systems, contains phosphates.

Cat. #	Description	Unit	Price
A-NE-2840	Emerald premium WCMX	Gal. 4+	\$28.20 26.23

## GRAPH-TEK

### UNIV. FOUNTAIN SOLUTION

■ An alcohol/glycerine fountain solution especially formulated to perform with silver, paper, plastic and metal plates. Color changes from red to yellow when the pH in the fountain reaches 5.8. Highly buffered to resist hydroxides that enter fountain causing the pH to rise.

Cat. #	Unit	Price
A-TG-U	Gal. 4+	\$23.40 21.75

## TWO-PART FOUNTAIN SOLUTIONS

### EMERALD® JR SERIES

Each EMERALD® JR SERIES fountain solution contains built-in ink drying stimulators that will decrease both setting and drying time of even the toughest inks. EMERALD® JR will also keep open the most difficult reverses on sheetfed presses. Used with ARS-F or ARS-JP, EMERALD® JR effectively eliminates alcohol.

There is an EMERALD® JR available for every water type. Further, the EMERALD® JRZ is designed for use with the aqueous plates to help eliminate blinding problems.

Cat. #	Description	Unit	Price
A-NE-2637	Emerald JR-Soft Water	Gal. 4+	\$23.30 21.67
A-NE-2716	Emerald JRM-Medium Water	Gal. 4+	23.30 21.67
A-NE-2709	Emerald JRH-Hard Water	Gal. 4+	23.30 21.67
A-NE-2965	Emerald JRSP-Soft Water (Extra Desensitizing)	Gal. 4+	23.30 21.67
A-NE-2977	Emerald JRMP-Medium Water (Extra Desensitizing)	Gal. 4+	23.30 21.67

### EMERALD® ADASERIES

The EMERALD® ADASERIES is predominantly a sheetfed fountain solution, which will eliminate alcohol when used with ARS-F or ARS-JP. The EMERALD® ADA formulations contain strong buffer systems for use in hard-water conditions or with alkaline paper.

Cat. #	Description	Unit	Price
A-NE-2959	Emerald ADAS Deionized to Soft Water	Gal. 4+	23.30 21.67
A-NE-2920	Emerald ADA- Medium to Hard Water	Gal. 4+	23.30 21.67

## GRAPH-TEK

### OFFSET ETCH-BLUE

■ A special chemical formulation designed to supply sufficient moisture to master surfaces during the initial wet-out thereby permitting the master surface to resist ink in the non-image area. Recommended for use with A.B. Dick® 369 and 1600/1700 Systems and for etching Direct Image Masters. Color; Blue. Comparable to A.B. Dick® 4-1015. Excellent chrome cylinder pickling agent.

Cat. #	Unit	Price
A-TF-P	Gal. 4+	\$21.00 19.50







EMERALD®

DAMPENING FOUNTAIN SOLUTIONS

EMERALD® Q SERIES

The EMERALD® PREMIUM Q Series is designed for fast start-ups on high-speed web and sheet fed presses. There are one-step formulas for brush and continuous dampening systems.

CONTINUOUS DAMPENING

EMERALD® PREMIUM DAQ

Contains no added phosphate-perfect for catalytic emission systems. It also eliminates blinding associated with aqueous plates.

Cat. #	Description	Unit	Price
A-NE-2879	Emerald premium DAQ	Gal. 4+	\$28.20 26.23

EMERALD® PREMIUM PAQ

A highly buffered fountain solution to combat the pH drift associated with running alkaline papers and hard-water conditions.

Cat. #	Description	Unit	Price
A-NE-2941	Emerald premium PAQ	Gal. 4+	\$28.20 26.23

BRUSH DAMPENING

EMERALD® BRQ

Formulated to eliminate blinding often associated with aqueous plates. The EMERALD® BRQ provides a strong buffering system to provide maximum defense against paper and ink contamination and combat hard-water conditions.

Cat. #	Description	Unit	Price
A-NE-2961	Emerald BRQ	Gal. 4+	\$23.30 21.67

FOUNTAIN SOLUTION ADDITIVE

FOAM ELIMINATOR

BE-DONE

Be-Done is designed to suppress and eliminate any foam generated in recirculating and dampening systems. It is also useful in eliminating foam when it occurs in the finisher tank of automatic plate processors. BE-DONE is safe, non-flammable, white in color, with a mild odor, and is nondamaging to equipment and other materials. It blends easily with all liquids.

Cat. #	Description	Unit	Price
A-NF-7023	BE-DONE	Qt. 12+	\$12.32 11.45



EMERALD®

ALCOHOL SUBSTITUTES

ARS-F

ARS-F has proven to be effective at eliminating alcohol on presses equipped with continuous dampening systems. This all-purpose alcohol substitute works well with any of our one or two step fountain solutions.

Also Available: ARS-JP

Cat. #	Description	Unit	Price
A-NA-2628	ARS-F Alcohol Substitute	Gal. 4+	30.05 27.95
A-NA-2873	ARS-JP- Alcohol Substitute	Gal. 4+	30.05 27.95

ARS-X

NON-VOC ALCOHOL SUBSTITUTE

ARS-X has proven to be effective at eliminating alcohol on presses equipped with continuous dampening systems. This substitute contains no VOC and, when used in conjunction with Emerald ADAseries fountain solutions, provides a non-VOC alcohol replacement package.

Cat. #	Description	Unit	Price
A-NA-2951	Alcohol Substitute	Gal. 4+	30.05 27.95

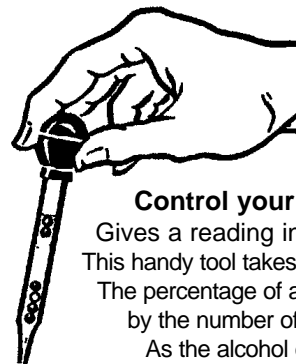

Alcohol Tester

Control your alcohol for better printing!

Gives a reading in seconds with no fuss or bother. This handy tool takes the guesswork out of alcohol control. The percentage of alcohol in the fountain is determined by the number of balls that float (as listed above). As the alcohol evaporates more balls will rise indicating the need for adding alcohol.

Full instructions included with each tester.

CAT# AL-BT	Range 0-28%	\$15.50
------------	-------------	---------

0.0 - 6.0  
pHydrion  
Test Strips

Use for testing the acidity of fountain solution. Essential for the clean, sharp reproduction resulting in high quality printing. 100 test strips per vial.

CAT# PH-TS	Range 0.0-6.0%	\$6.00
------------	----------------	--------





## ROLLER and BLANKET WASH

### WASH R-228®

■ WASH R-228® is a superior, water-miscible, one-step, ink glaze preventive roller and blanket cleaner and conditioner for use on all presses. It is a combination of fine ink solvents that penetrate deep into the rubber to get at the imbedded layers of dried ink, dirt, gum and lint. At the same time, its rubber rejuvenator, "Resilium," restores precious antioxidants and plasticizers that are constantly being leached out of rubber.

Cat. #	Unit	Price
A-NW-7011	Gal.	\$19.40
	6+	18.04
A-NW-7011P	5/Gal	88.56

### WASH R-228® ODERLESS

■ WASH R-228® ODERLESS is a version of our famous WASH R-228® containing no chlorinated solvent. The only difference between the regular version and the odorless is that WASH R-228® ODERLESS is a combustible mixture. The removal of chlorinated solvents provides easier disposal and fewer health concerns.

Cat. #	Unit	Price
A-NW-7117	Gal.	\$17.60
	6+	16.37
A-NW-7117P	5/Gal	79.13

### QUICK WASH

■ QUICK WASH is a very fast drying roller and blanket wash. It is ideal for small duplicator presses for either hand wash-up or automatic wash-up attachments.

Quick multi-action formula - instantly breaks down and dissolves ink components and varnish. Gets rollers and blankets deep-down clean and leaves no oily residue.

Cat. #	Unit	Price
A-NQ-7059	Gal.	\$15.26
	6+	14.19
A-NQ-7059P	5/Gal	71.50

## SIEBERT PRODUCTS

### PRESS WASH RB-9010H

■ A very quick-drying roller and blanket wash designed for smaller presses and offset duplicators, and for use on larger presses where a faster drying blanket wash is preferred. Its high solvent power makes ink removal quick and easy, and its drying speed keeps down-time to a minimum.

This product contains no **CHLORINATED SOLVENTS**.

Cat. #	Unit	Price
A-TS-W	Gal.	\$11.00
	6+	10.25
A-TS-W5	5/Gal	48.00



## LUBRICANTS

### ANCHOR OILS 302 & 502

■ ANCHOR OIL302 and 502 are high-grade, virgin-base, clinging-type lubricating oils with greater load carrying capability than similar viscosity oils, as well as greater service life.

#### -----SPECIFICATIONS-----

	302	502
Viscosity-SUS@ 100°F (Saybolt Universal Seconds)	300-330 sec.	500-550 sec.
Viscosity-Engler 50°C	5.3	9.0
Flash Point	400°F	460°F
Pour Point	-10°F	-5°F

Copper Strip Test (ASTM).....Passed

Additives.....Rust, Foam and Oxidation Inhibitors.

ANCHOR OIL302 is in the SAE 20 classification and ANCHOR OIL502 is in the SAE 30/40 classification. They can be safely added to any other high-grade industrial lubricating oil without making the resulting mix unstable. However, the clinging ability of 302 and 502 would, of course, be diluted.

### ANCHOR OIL 302

Cat. #	Unit	Price
A-NO-7087	Gal.	\$21.52
	6+	20.01
A-NO-7087P	5-Gal. pail	103.56

### ANCHOR OIL 502

Cat. #	Unit	Price
A-NO-7088	Gal.	\$21.52
	6+	20.01
A-NO-7088P	5-Gal. pail	103.56

## SIEBERT PRODUCTS

### ELECTROSTATIC ETCH

■ A conversion etch and fountain solution for electrostatic offset masters. Designed especially for semi-automatic camera platemakers.

Use undiluted as a conversion etch. For use as a fountain solution, dilute 1 part of ELECTROSTATIC ETCH with 7 to 10 parts of water.

Cat. #	Description	Unit	Price
ES-P2	Electrostatic Etch	Gal.	\$15.25
		4+	14.30
ES-P5	Electrostatic Etch	5-Gal. pail	66.20
ES-P55	Electrostatic Etch	55-Gal. drum	591.80



# ACCEL

Graphic Systems

## FOUNTAIN SOLUTION PRODUCTS



### FOUNTAIN ADDITIVE

■ APA is effective at eliminating alcohol on presses equipped with continuous damping systems. This substitute, when used in conjunction with Accel's FC 1000 fountain solution, provides a low VOC alcohol replacement package.

Cat. #	Unit	Price
APA-FA	Gal.	\$32.50
	Case(4, 1gal)	118.00



### FOUNTAIN CONCENTRATE FOR METAL PLATES

■ FC 1000 Fountain Concentrate is a one-step alcohol replacement fountain solution specifically formulated to run on aqueous plates. It is designed to eliminate the blinding often associated with aqueous plate images. The strong buffer system incorporated in the formula allows it to be used in all but the hardest of water and is especially useful when running alkaline papers (due to its increased resistance to contamination). It has proven to be very successful on continuous dampeners such as Crestline® because of its ability to resist feedback on the water rollers.

Cat. #	Unit	Price
FC1000	Gal.	\$32.50
	Case(4, 1gal)	118.00



### MULTI-PURPOSE FOUNTAIN CONCENTRATE

■ MP1000 Multi-Purpose Fountain Concentrate is an all purpose fountain concentrate for use with all plates (silver type, metal, electrostatic and laser), papers (coated, uncoated, etc.), and inks (petroleum base, soy, etc.). MP1000 is designed especially for continuous damping systems such as Crestline® and does NOT contain alcohol or VOC's.

Cat. #	Unit	Price
MP1000	Gal.	\$32.50
	Case(4, 1gal)	118.00



### MULTI-PURPOSE FOUNTAIN CONCENTRATE FOR SILVER EMULSION & METAL PLATES

■ MP2000 Multi-Purpose Fountain Concentrate is a one-step, universal product that does not require alcohol or, generally, alcohol substitutes. Formulated to run all silver-type and metal plates, MP2000 is designed especially for Accel's continuous damping Crestline® system. It is a buffered product that has an expected pH range of 4.0-4.5, and water hardness is not an issue with MP2000

Cat. #	Unit	Price
APA-FA	Gal.	\$32.50
	Case(4, 1gal)	118.00



### ROLLER DEGLAZING PASTE

■ Compound X Roller Deglazing Paste is a specially formulated, deep cleaning, roller deglazing paste that is excellent for use in both ink trains and continous feed dampeners like Crestline®. Glazed rollers give substandard performance, resulting in poor print quality. Compound X removes glaze from rollers and returns them to a "like new" condition for optimum press performance.

Cat. #	Unit	Price
R-208	8 oz tube	\$ 8.00
R-300	2 lb tub	30.00
	Case(8, 2lb tubs)	184.00

### LIBITE TYPE WASH



Instantly penetrates and removes hard dry ink, varnish and glaze from type forms, press plates, rollers, blankets, ink fountains, cylinders and press parts. Litho & letter pressmens favorite for over fifty years.

Cat. #	Unit	Price
LB-1	Gal.	\$13.30
	6+	12.37
LB-5	5/Gal.	60.00

# ORDER FORM

**TO ORDER:**

*Please make  
copies of this  
form before  
filling out for  
future orders.*

- 1. FAX order to:** 651-917-8440
- 2. PHONE orders to:** 651-917-8444 or 1-800-829-4815
- 3. MAIL orders to:** Perfection Type Inc.  
1050 33rd Ave. SE  
Suite 1000  
Mpls., MN 55414

Purchase Order Number \_\_\_\_\_ Date \_\_\_\_\_

Buyer Name and Title \_\_\_\_\_ Telephone \_\_\_\_\_

**Ship To:**

Company Name \_\_\_\_\_

Address \_\_\_\_\_

City \_\_\_\_\_

State \_\_\_\_\_ Zip \_\_\_\_\_

Attention To: \_\_\_\_\_

**Bill To:**

Company Name \_\_\_\_\_

Address \_\_\_\_\_

City \_\_\_\_\_

State \_\_\_\_\_ Zip \_\_\_\_\_

American Express, Visa or Mastercard # \_\_\_\_\_ Expiration Date \_\_\_\_\_

Quantity	Catalog #	Model # and/or Description	Unit Price	Total Price

**Billing Information**

Minimum Order: \$25.00  
 Prices subject to change without notice.  
 Present customers with an open account and good credit standing will be invoiced with the terms of Net 30 days.  
 New customers may send a check with order or we will send the order COD.  
 New customers may also request a credit application to open an account. Please allow 1 week for a credit check.  
 \*If you are a tax exempt organization we will need a Certificate of Exemption Form on file.  
 Returns may be subject to a restocking charge.

Subtotal	
Sales Tax (if applicable)*	
Shipping and Handling**	
<b>TOTAL</b>	

All returned goods must accompany a return authorization number with invoice number, date of invoice and purchase order before any credit will be issued.  
 No returns accepted after 30 days from date of invoice.  
 Special order or modified equipment may not be returned.  
 \*\*Shipping charges plus a \$2.00 handling charge per order will be added to your order. We will select the fastest and most economical method of shipment, usually U.P.S.

**Thank you for your order!**